

MODEL:

PDU330AT6L2130

3-Phase Monitored 1U Rackmount PDU with ATS



**208V
3-Phase Input**



**Automatic
Transfer Switch**



**208V Single-
Phase Output**



**8.6kW
Load Capacity**



**Multimode
Load Meter**



**Network
Interface**



**1U Horizontal
Rackmount**



L21-30P Input

- A** Multi-Function Display
- B** 20A Double Pole Magnetic Circuit Breakers
- C** ATS Output Mating Receptacle
- D** Network Interface
- E** 6 ft. Input Power Cord (x2)
- F** L21-30P Twist-Lock Input Plug (x2)
- G** Grounding Lug
- H** Rackmounting Brackets

Also Includes: Owner's manual, slide rail mounting kit and configuration cable.

Multi-function display reports Current, Voltage, Frequency, Kilowatts, Power Factor and Temperature*, plus Source A/B Preferred, Available and In-Use Status.
*Requires ENVIROSENSE option.

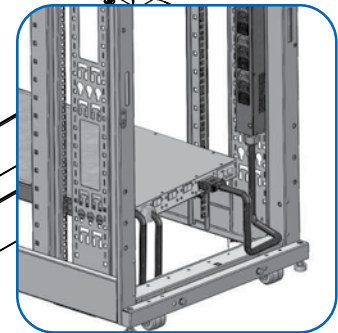
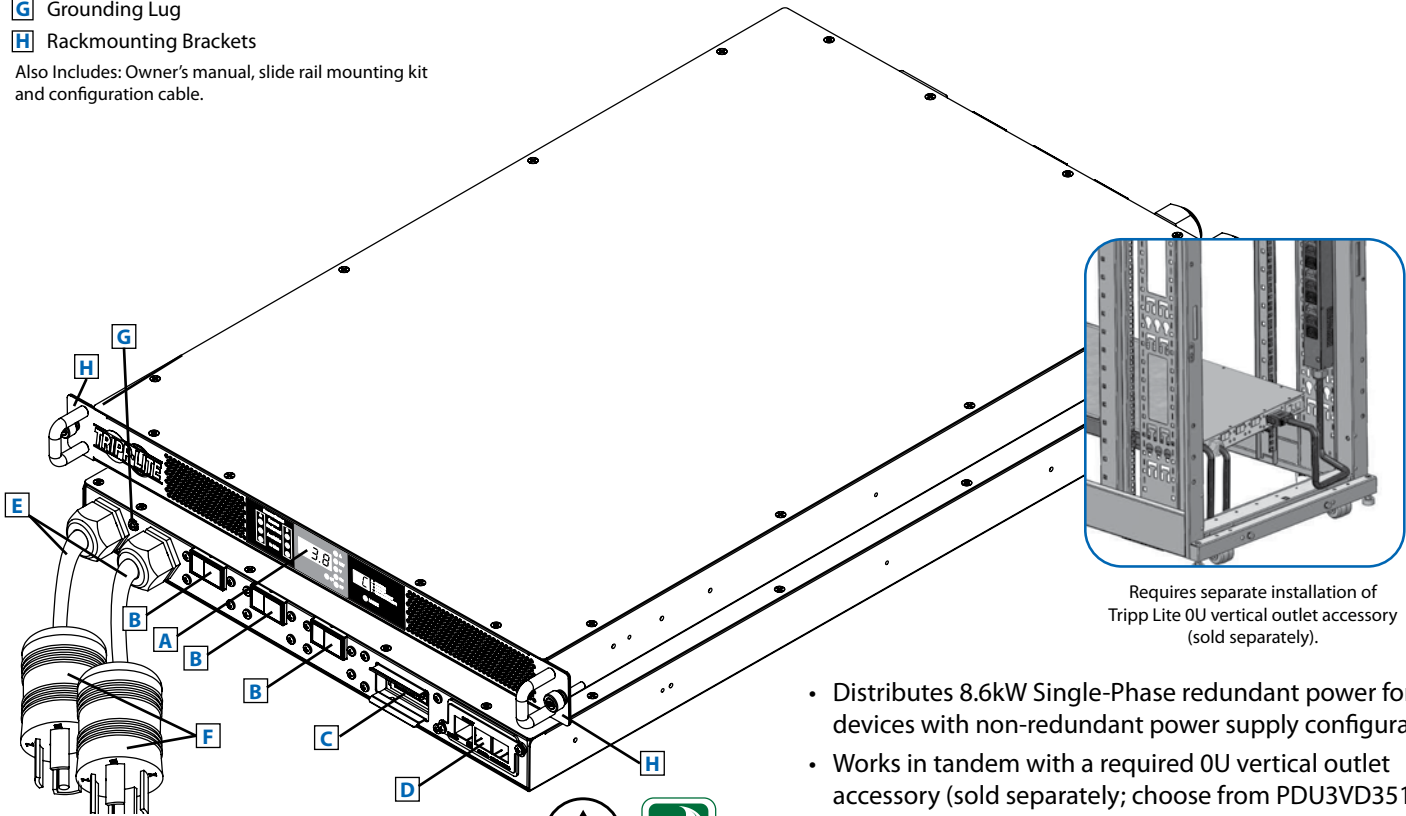
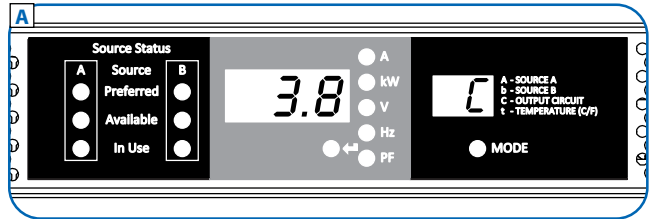

Requires separate installation of Tripp Lite 0U vertical outlet accessory (sold separately).

Specifications

Model	PDU330AT6L2130
Voltage	208V (3-Phase Input/Single-Phase Output)
Frequency	50 / 60 Hz
Load Capacity	8.6kW
Input Plug	L21-30P
Input Cord Lengths	6 ft. (1.8 m)
Outlets	Varies (Depends on Installed 0U Outlet Accessory)
Primary Mounting Option	1U Horizontal (0U Outlet Accessory Required)
Unit Weight & Dimensions	26.8 lb / 1.72 x 16.9 x 26 (HxWxD in inches) 12.2 kg / 44 x 429 x 660 (HxWxD in mm)
Standards	See next page for detailed unit measurements. Tested to UL/CSA 60950-1 (USA, Canada), FCC Class A, RoHS

Tripp Lite has a policy of continuous improvement. Specifications are subject to change without notice.

- Distributes 8.6kW Single-Phase redundant power for devices with non-redundant power supply configurations
- Works in tandem with a required 0U vertical outlet accessory (sold separately; choose from PDU3VD351, PDU3V20D354, PDU3V20D354A or PDU3V20D354B, depending on application)
- Remote monitoring via SNMP, Web or Telnet
- Real-time load current display with billing-grade accuracy (+/-1%)

SEE NEXT PAGE FOR DETAILED UNIT MEASUREMENTS



1111 W. 35th Street
Chicago, IL 60609 USA
773.869.1234
www.tripplite.com

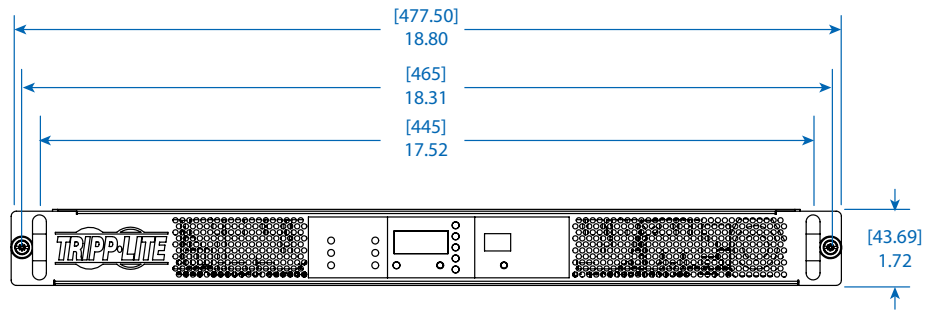

FRONT VIEW

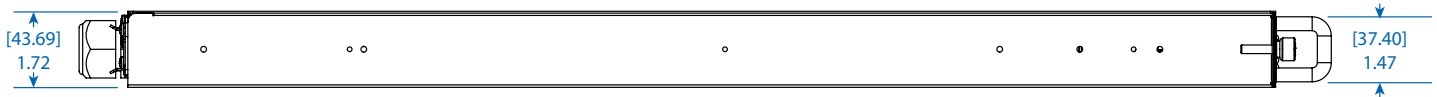

SIDE VIEW

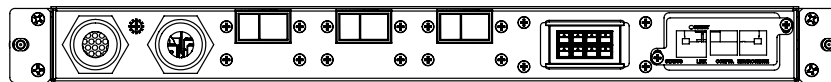

REAR VIEW

MODEL:
PDU330AT6L2130



1111 W. 35th Street
Chicago, IL 60609 USA
773.869.1234

www.tripplite.com

Dimensions: [mm] INCHES

Tripp Lite has a policy of continuous improvement. Specifications are subject to change without notice.

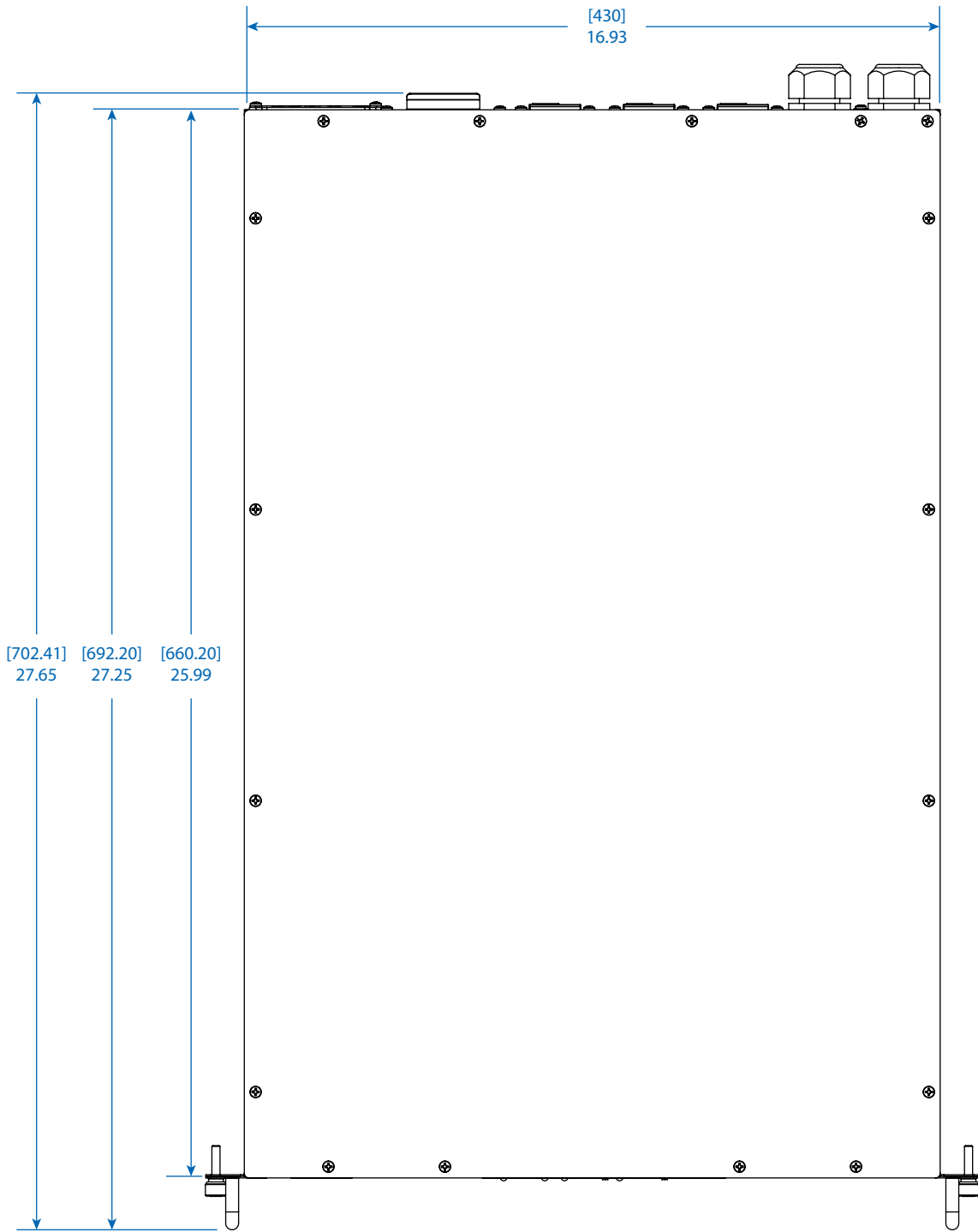

TOP VIEW

MODEL:
PDU330AT6L2130



1111 W. 35th Street
 Chicago, IL 60609 USA
 773.869.1234
www.tripplite.com

Dimensions: [mm] INCHES

Tripp Lite has a policy of continuous improvement. Specifications are subject to change without notice.