



SUNON

SPECIFICATION FOR APPROVAL

CUSTOMER :

DESCRIPTION : AXIAL AC FAN

MODEL : A1259-HBL
TC

APPROVED NO :

(AUTHORIZED)

APPROVED BY :



DAWN	Yuchen 8/3	CHKD.	<i>Kaddy</i>	APPD.	<i>[Signature]</i>	SPEC. NO.	A250001
						ISSUE DATE	08.03.2000
						EDITION	0
						REVISE DATE	
						E.SPEC	EA25001

建準電機工業股份有限公司
 SUNONWEALTH ELECTRIC MACHINE INDUSTRY CO., LTD.
 12FL., 120 CHUNG CHENG 1ST RD., TEL:886-7-7163069(41 LINES)
 KAOHSIUNG, TAIWAN, R. O. C. FAX:886-7-7163086~89

MODEL NUMBERING SYSTEM

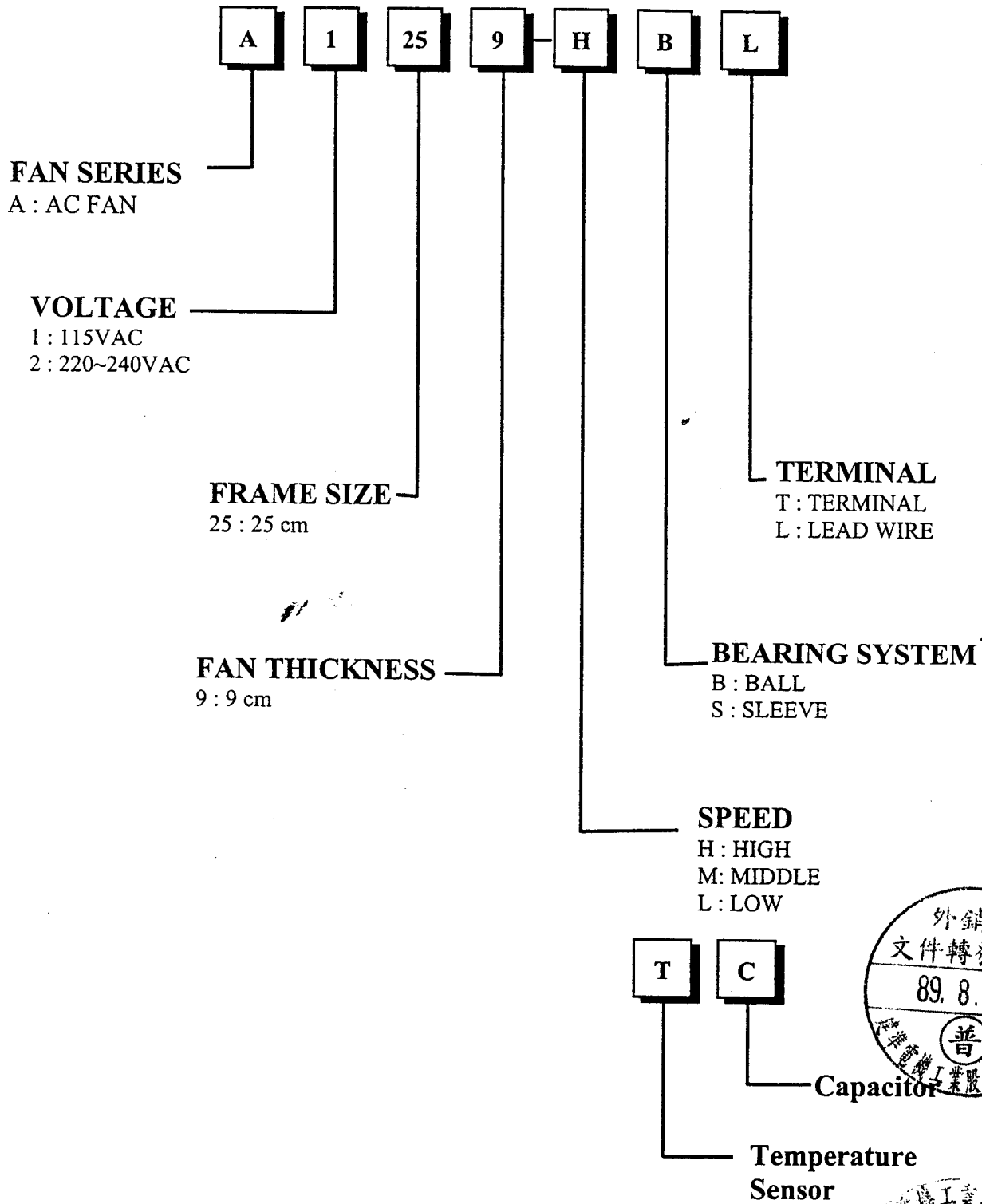

建準電機工業股份有限公司 SUNONWEALTH ELECTRIC MACHINE INDUSTRY CO., LTD	SPEC. NO.	A250001	REVISE DATE	發部
	ISSUE DATE	08. 03. 2000	EDITION	89. 8. 15
	PAGE	1 OF 6		發行章

AXIAL AC FAN

MODEL : A1259-HBL
TC

CHARACTERISTICS

- 1. Motor Design : Reliable Shaded-Pole Motor Contraction.
- 2. Insulation Resistance : 500Megohms minimum at 500 VDC.
- 3. Dielectric Strength : 1500 VAC for one minute.
- 4. Motor Protection : Thermal protected.
- 5. Noise Level : Measured in an semi-an echoic chamber with background noise level below 15 dB(A). The fan is running in free air with microphone at a distance of one meter from the fan intake.
- 6. Air Performance : Measured by a double chamber. The value are recorded when the fan speed is stabilized at rated voltage.
- 7. Tolerances : $\pm 15\%$ on rated power and current.



SPEC. NO.	A250001	REVISE DATE	
ISSUE DATE	08. 03. 2000	EDITION	89. 8. 15
PAGE	2 OF 6		



SPECIFICATIONS

**MODEL : A1259-HBL
TC**

- 1-1. Rated Voltage : 115 VAC 50/60 Hz
- 1-2. Operating Voltage Range : 80-125 VAC
- 1-3. Starting Voltage : 80 VAC
- 1-4. Rated Speed : 2150/2000 RPM ± 10%
- 1-5. Air Delivery : 867/806 CFM
- 1-6. Static Pressure : 0.46/0.37 Inch-H₂O
- 1-7. Rated Current : 0.50/0.60 AMP
- 1-8. Input Power : 57/68 WATTS
- 1-9. Noise Level : 57/56 dB(A)
- 1-10. Direction of Rotation : Counter-clockwise viewed front fan blade
- 1-11. Motor Protection : Thermal Protected.
- 1-12. Operating Temperature : -10 to +80 Deg.C
- 1-13. Storage Temperature : -30 to +80 Deg.C
- 1-14. Bearing System : Precise ball bearing system
- 1-15. Weight : 2000g
- 1-16. Vibration : Vibration of acceleration 1.5G and Frequency 5~50~5Hz is applied in the 3 directions(X,Y,Z) for 30 minutes, each Direction at the cycle of 1 minute.
- 1-18. Life Expectancy : 50,000 Hrs at 25°C.



建準電機工業股份有限公司
SUNONWEALTH ELECTRIC
MACHINE INDUSTRY CO., LTD

SPEC. NO.	A250001	REVISED DATE	發 行 部
ISSUE DATE	08. 03. 2000	E D I T I O N	89. 8. 015
PAGE	3 OF 6		

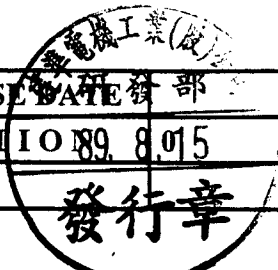

MODEL : A1259-HBL
TC

PERFORMANCE CURVES

STATIC
PRESSURE

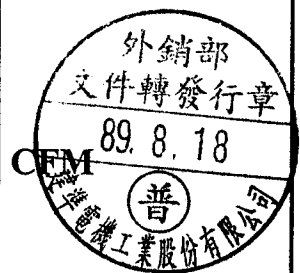
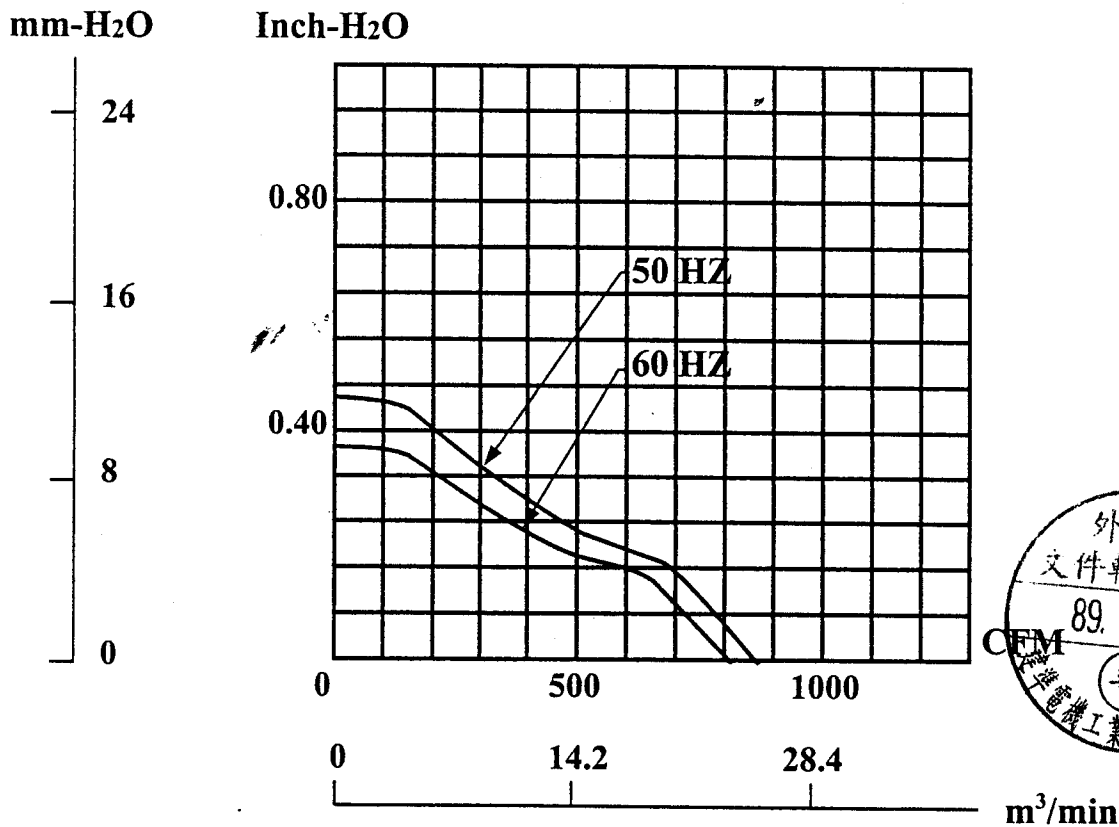

建準電機工業股份有限公司
SUNONWEALTH ELECTRIC
MACHINE INDUSTRY CO., LTD

SPEC. NO.	A250001
ISSUE DATE	08.03.2000
PAGE	4 OF 6

REVISION
EDITION 89.8.15

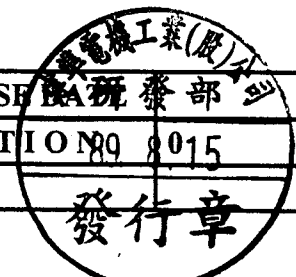

MATERIAL

2. Material

- 2-1. Frame : DIE-CAST ALUMINUM
- 2-2. Impeller : Thermoplastic PBT of UL 94V-0
- 2-3. Lead Wire : UL1015,18AWG

DIMENSIONS

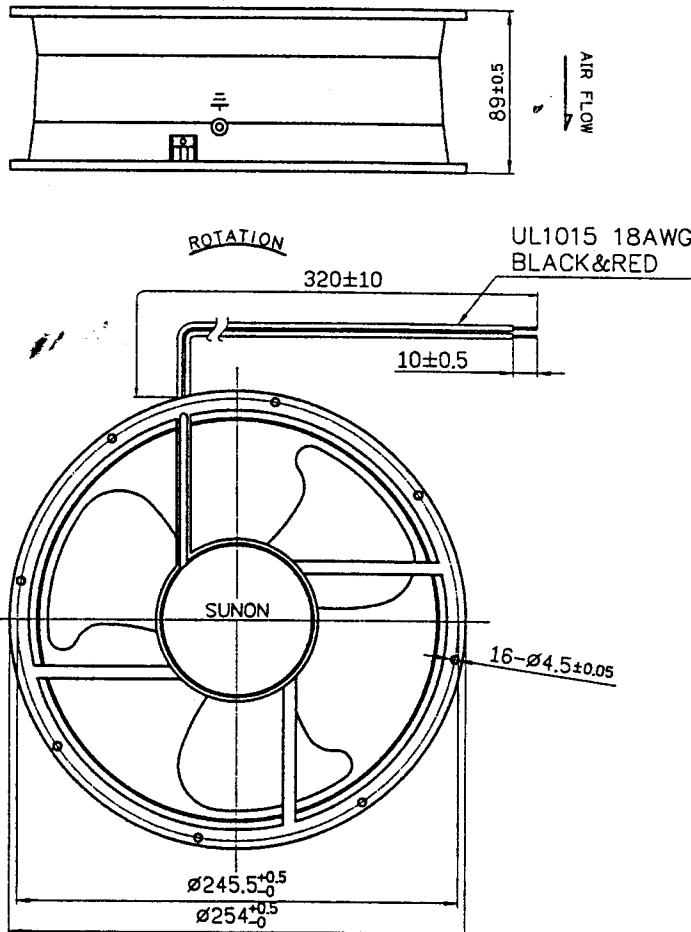

Air Flow Direction: Label side.

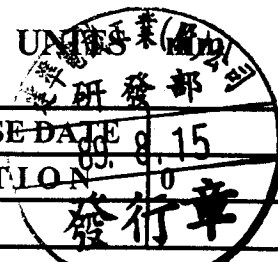

建準電機工業股份有限公司 SUNONWEALTH ELECTRIC MACHINE INDUSTRY CO., LTD	SPEC. NO.	A250001	REVISE DATE	89. 8. 15
	ISSUE DATE	08. 03. 2000	EDITION	0
	PAGE	5 OF 6		

Notes

1. SUNON will not guarantee the products if the application of our products is exceeded the limitation which is specified on this specification.
2. In case of change of the specification specified on this document, a written notice is requested in advance.
3. Please do not touch the impeller with pressure and never bring the fan with lead wire. The bearings and lead wire may be damaged.
4. No guarantee on the products against the safety problem or failure caused by powder dust, drop of water or insect.
5. If there is any data or related documentation different from this data sheet, this data sheet is the principal reference.
6. For the purpose of MIS, please indicate SPEC No. on every order.
7. In case of the fan has no polarity protection function, wires with same color (electrode) must be connected together during the assembly. (i.e. red + red, black + black) or the fan will be damaged immediately.
8. Please do not use the fan in the environment of corrosive gas or liquid or any detrimental gas.
9. Please do not store the fan in the environment of high / low temperature, high humidity or any detrimental gas. Please store the fan within 6 months, every 6 months, there shall be a linkage of electric current to the fan, even though the fan is stored in room temperature.
10. While the fan is in operation, please do not lock the fan intentionally for a long period of time, since the continuous stoppage will result in over-heat and damage of the fan.
11. During the installation of the fan, please pay substantial attention to possible noise cause by resonance vibration and vibration.
12. During the testing of the fan, please be sure to use finger guard to insure safety.
13. Unless otherwise specified, if there is any doubt in the judgement, the temperature and relative humidity range of environment will be take in according to the standard condition as 25°C and 65%.

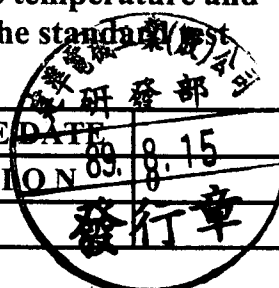

建準電機工業股份有限公司 SUNONWEALTH ELECTRIC MACHINE INDUSTRY CO., LTD	SPEC. NO.	A250001	REVISED DATE	89. 8. 15
	ISSUE DATE	08. 03. 2000	EDITION	89. 8. 15
	PAGE	6 OF 6		