

Dual IGBTMOD™ Compact IGBT Series Module 800 Amperes/600 Volts

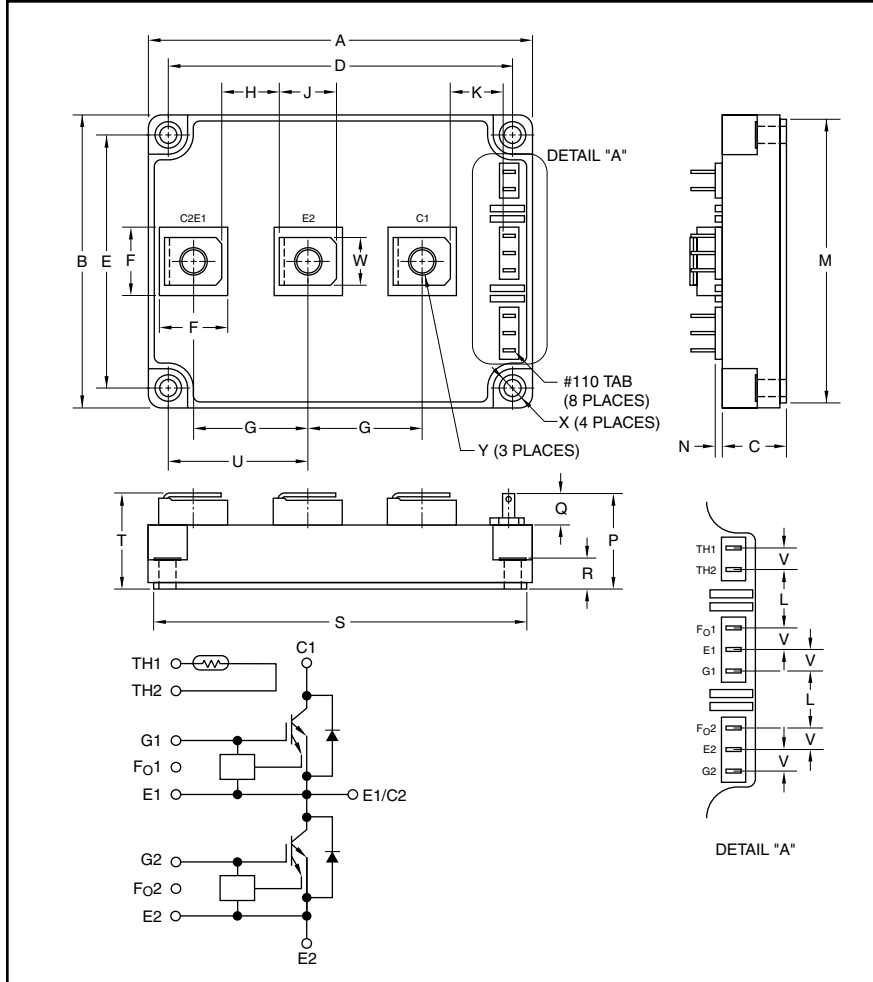

Outline Drawing and Circuit Diagram

Dimensions	Inches	Millimeters
A	4.92±0.04	125.0±1.0
B	3.78±0.04	96.0±1.0
C	0.84±0.04	21.3±1.0
D	4.49±0.03	113.0±0.8
E	3.30±0.03	84.0±0.8
F	0.86±0.04	22.0±1.0
G	1.46±0.04	37.0±1.0
H	0.75±0.04	19.0±1.0
J	0.71±0.04	18.0±1.0
K	0.73±0.04	18.6±1.0
L	0.59±0.04	15.0±1.0
M	3.66±0.03	93.0±0.8

Dimensions	Inches	Millimeters
N	0.07±0.04	1.8±1.0
P	1.24±0.04	31.5±1.0
Q	0.40±0.03	10.2±0.8
R	0.34±0.03	8.7±0.8
S	4.92±0.04	125.0±1.0
T	1.24-0.01/+0.04	31.5+2.0/-0.8
U	1.81±0.04	46.0±1.0
V	0.22±0.04	5.6±1.0
W	0.63±0.03	16.0±0.8
X	0.21 Dia.	5.5 Dia.
Y	M8 Metric	M8

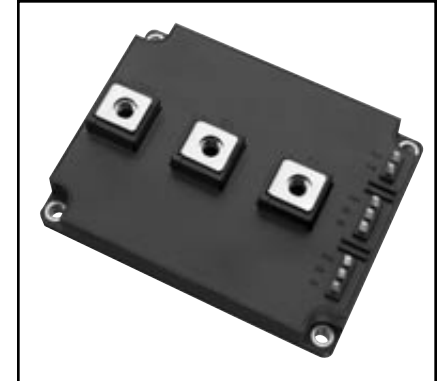

Description:

Powerex Dual IGBTMOD™ Compact IGBT Series Modules are designed for use in switching applications. Each module consists of two IGBT Transistors in a half-bridge configuration, with each transistor having a reverse-connected super-fast recovery free-wheel diode. All components and interconnects are isolated from the heat sinking baseplate, offering simplified system assembly and thermal management.

Features:

- Over-Current and Over-Temperature Protection
- Low $V_{CE(sat)}$
- Isolated Baseplate for Easy Heat Sinking

Applications:

- AC Motor Control
- Motion/Servo Control
- UPS
- Welding Power Supplies
- Laser Power Supplies

Ordering Information:

Example: Select the complete part number from the table below -i.e. MG800J2YS50A is a 600V (V_{CES}), 800 Ampere Dual IGBTMOD™ Compact IGBT Series Module.

Type	Current Rating Amperes	V_{CES} Volts (x 10)
MG	800	60



Powerex, Inc., 200 E. Hillis Street, Youngwood, Pennsylvania 15697-1800 (724) 925-7272

MG800J2YS50A
Dual IGBTMOD™
Compact IGBT Series Module
 800 Amperes/600 Volts

Absolute Maximum Ratings, $T_j = 25^\circ\text{C}$ unless otherwise specified

Characteristics	Symbol	MG800J2YS50A	Units
Collector-Emitter Voltage	V_{CES}	600	Volts
Gate-Emitter Voltage	V_{GES}	± 20	Volts
Collector Current (DC)	I_C	800	Amperes
Forward Current (DC)	I_F	800	Amperes
Collector Dissipation ($T_C = 25^\circ\text{C}$)	P_C	2900	Watts
Power Device Junction Temperature	T_j	-20 to 150	$^\circ\text{C}$
Storage Temperature	T_{stg}	-40 to 125	$^\circ\text{C}$
Mounting Torque, M5 Mounting Screws	—	27	in-lb
Mounting Torque, M8 Main Terminal Screws	—	88	in-lb
Module Weight (Typical)	—	680	Grams
Isolation Voltage, AC 1 minute, 60Hz Sinusoidal	V_{ISO}	2500	Volts

Electrical and Mechanical Characteristics, $T_j = 25^\circ\text{C}$ unless otherwise specified

Characteristics	Symbol	Test Conditions	Min.	Typ.	Max.	Units
Gate Leakage Current	I_{GES}	$V_{GE} = \pm 20\text{V}, V_{CE} = 0\text{V}$	—	—	± 10	μA
Collector Cutoff Current	I_{CES}	$V_{CE} = 600\text{V}, V_{GE} = 0\text{V}$	—	—	1.0	mA
Gate-Emitter Cutoff Voltage	$V_{GE(off)}$	$I_C = 800\text{mA}, V_{CE} = 5\text{V}$	5.0	6.5	8.0	Volts
Collector-Emitter Saturation Voltage	$V_{CE(sat)}$	$V_{GE} = 15\text{V}, I_C = 800\text{A}, T_j = 25^\circ\text{C}$	—	2.4	3.0	Volts
		$V_{GE} = 15\text{V}, I_C = 800\text{A}, T_j = 125^\circ\text{C}$	—	2.6	3.3	Volts
Input Capacitance	C_{ies}	$V_{CE} = 10\text{V}, V_{GE} = 0\text{V}, f = 1\text{MHz}$	—	93000	—	pF
Gate-Emitter Voltage	V_{GE}		13.0	15.0	17.0	Volts
Gate Resistance	R_G		4.7	—	15.0	Ω
Inductive Load	$t_{d(on)}$		—	0.3	—	μs
Switching	t_r		—	0.25	—	μs
Times	t_{on}	$V_{CC} = 300\text{V}, I_C = 800\text{A},$	—	0.55	—	μs
	$t_{d(off)}$	$V_{GE} = \pm 15\text{V}, R_G = 4.7\Omega$	—	0.85	—	μs
	t_f		—	0.15	0.3	μs
	t_{off}		—	1.05	—	μs
Forward Voltage	V_F	$I_F = 800\text{A}, V_{GE} = -10\text{V}, T_j = 25^\circ\text{C}$	—	2.3	3.0	Volts
		$I_F = 800\text{A}, V_{GE} = -10\text{V}, T_j = 125^\circ\text{C}$	—	2.1	—	Volts
Reverse Recovery Time	t_{rr}	$I_F = 800\text{A}, V_{GE} = -10\text{V}, di/dt = 2000\text{A}/\mu\text{s}$	—	—	0.5	μs
Junction to Case Thermal Resistance	$R_{th(j-c)Q}$	IGBT (Per 1/2 Module)	—	—	0.043	$^\circ\text{C}/\text{Watt}$
	$R_{th(j-c)D}$	FWDi (Per 1/2 Module)	—	—	0.056	$^\circ\text{C}/\text{Watt}$
RTC Operating Current	I_{rtc}	$T_j = 25^\circ\text{C}$	1600	—	—	Amperes



Powerex, Inc., 200 E. Hillis Street, Youngwood, Pennsylvania 15697-1800 (724) 925-7272

MG800J2YS50A
Dual IGBTMOD™
Compact IGBT Series Module
800 Amperes/600 Volts

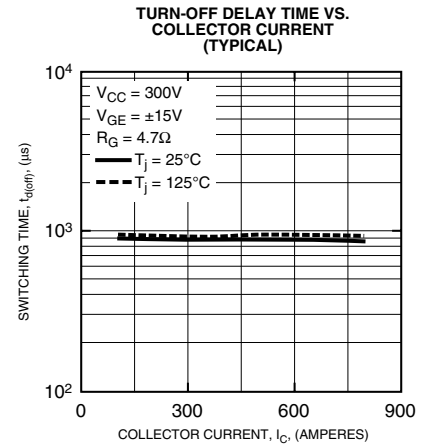
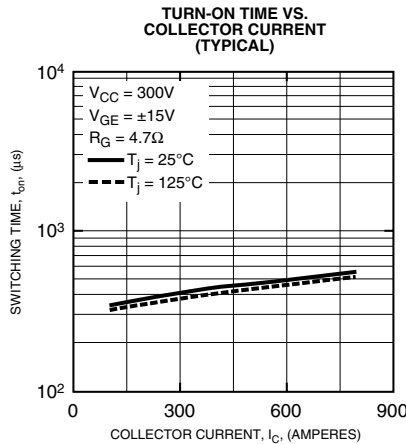
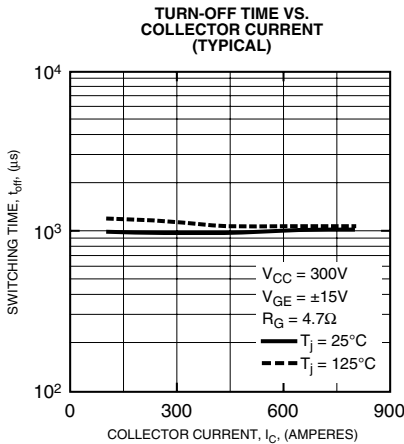
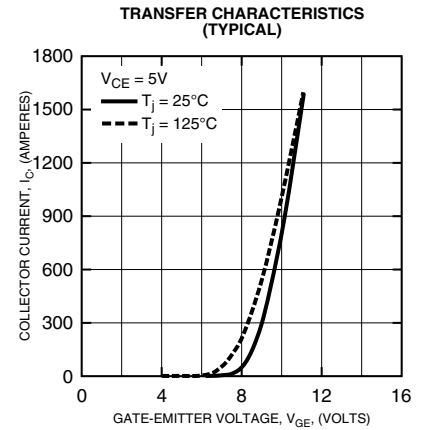
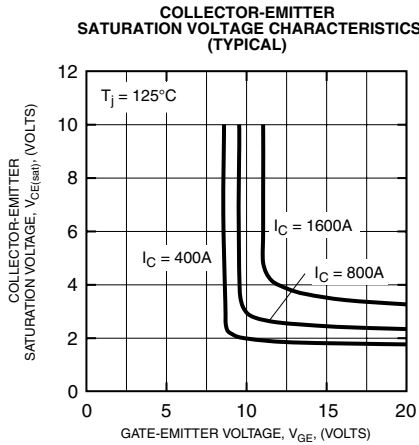
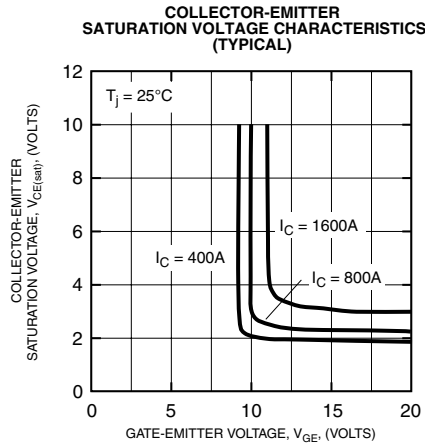
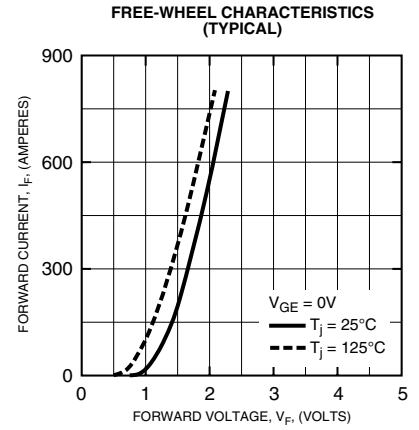
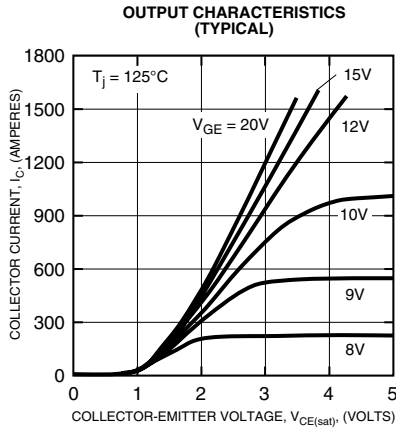
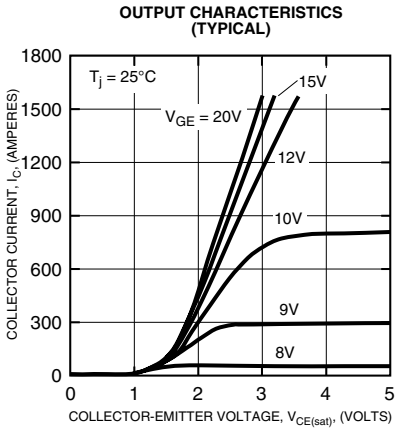



Powerex, Inc., 200 E. Hillis Street, Youngwood, Pennsylvania 15697-1800 (724) 925-7272

MG800J2YS50A
Dual IGBTMOD™
Compact IGBT Series Module
800 Amperes/600 Volts

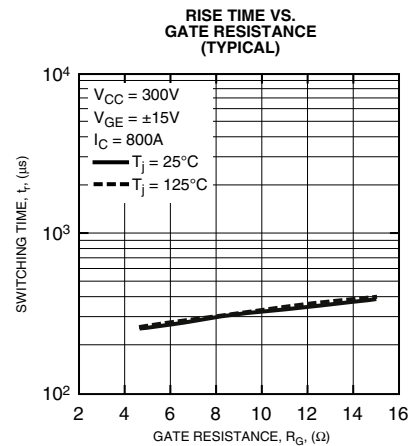
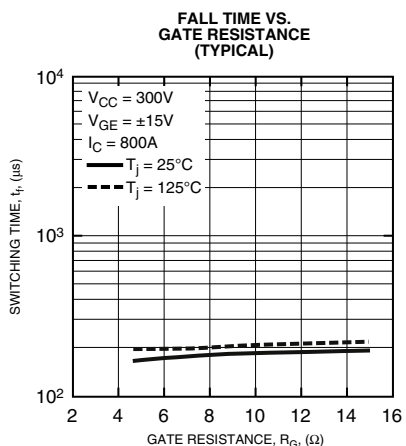
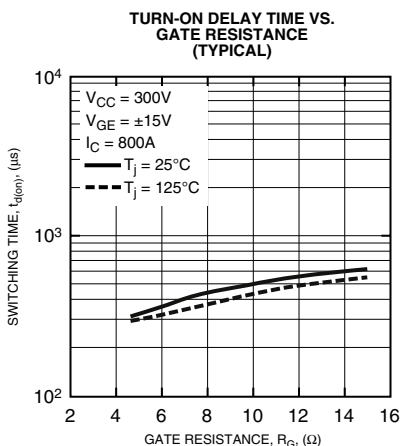
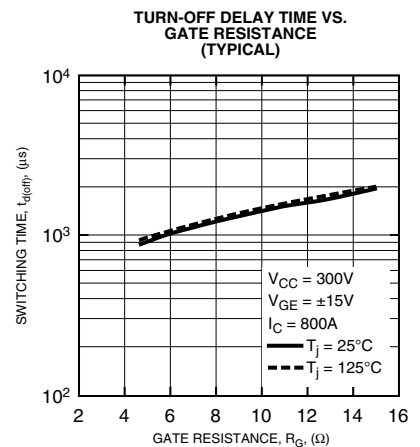
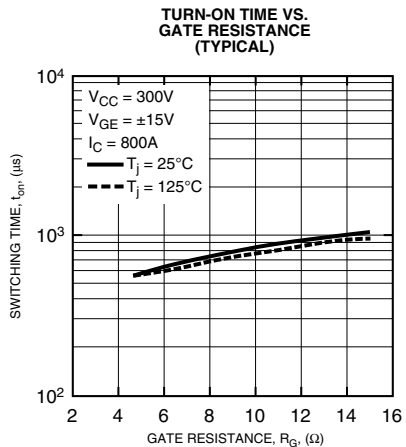
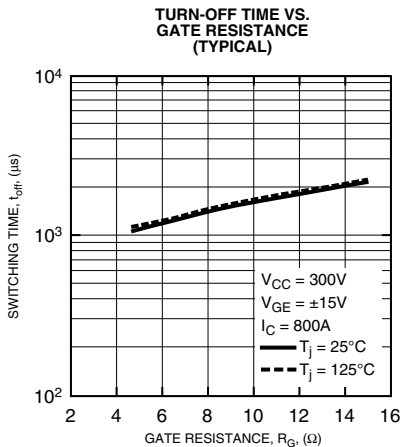
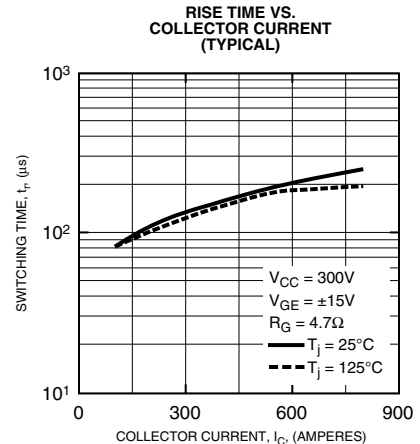
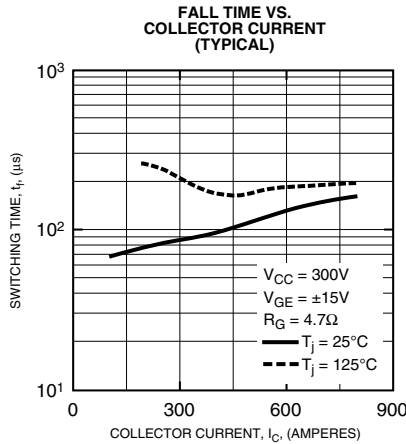
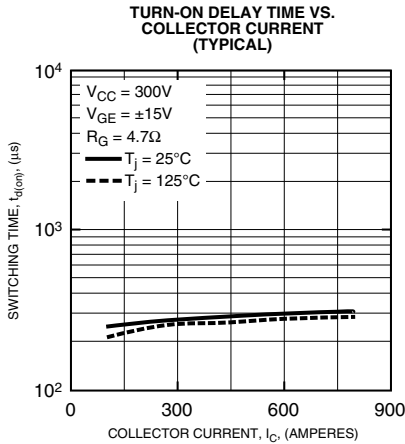



Powerex, Inc., 200 E. Hillis Street, Youngwood, Pennsylvania 15697-1800 (724) 925-7272

MG800J2YS50A
Dual IGBTMOD™
Compact IGBT Series Module
800 Amperes/600 Volts

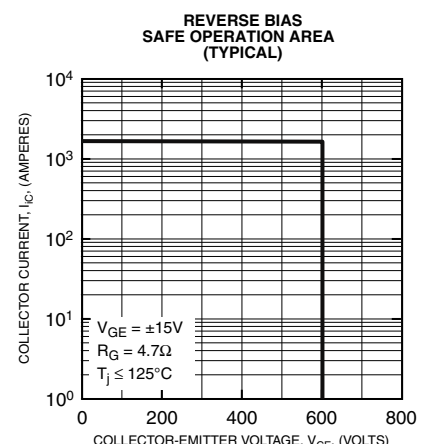
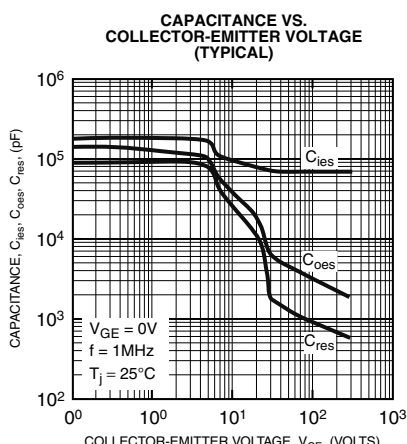
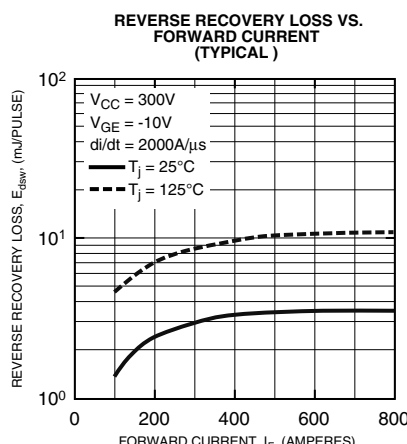
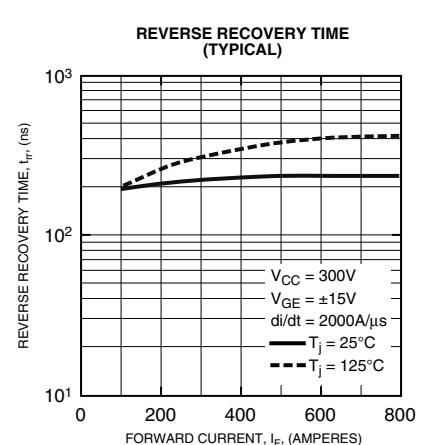
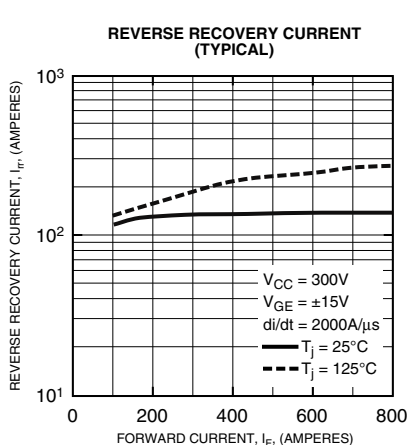
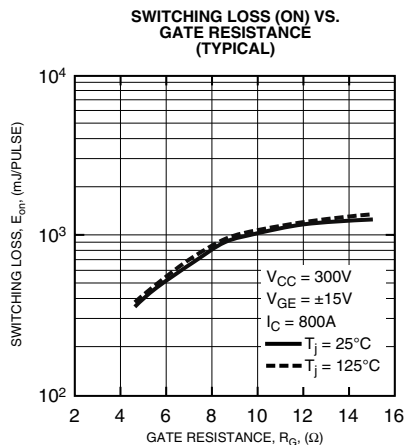
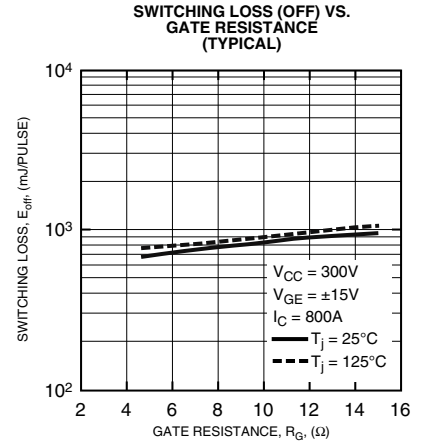
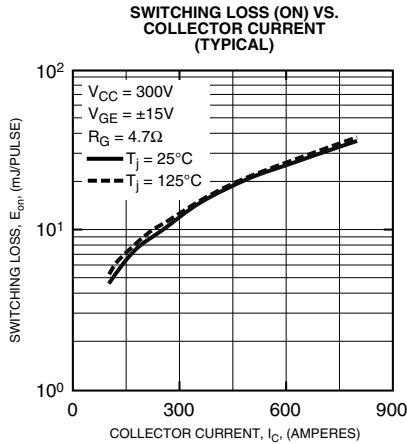
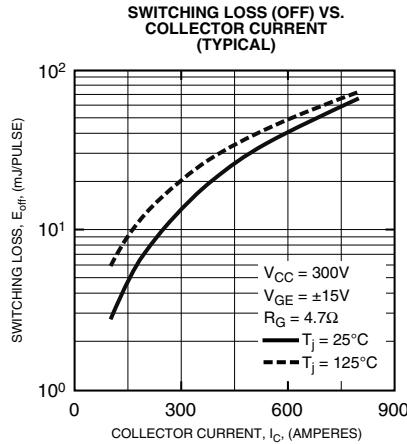

MG800J2YS50A
Dual IGBTMOD™
Compact IGBT Series Module
 800 Amperes/600 Volts

