

THIS DOCUMENT IS THE PROPERTY OF
KEYSTONE ELECTRONICS CORP. AND
SHALL NOT BE REPRODUCED, DISTRIBUTED
OR USED AS A BASIS FOR MANUFACTURE
WITHOUT PRIOR WRITTEN PERMISSION
FROM KEYSTONE ELECTRONICS CORP.

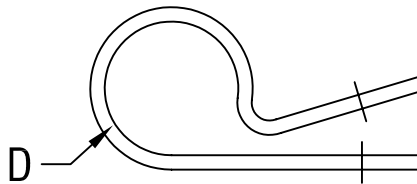
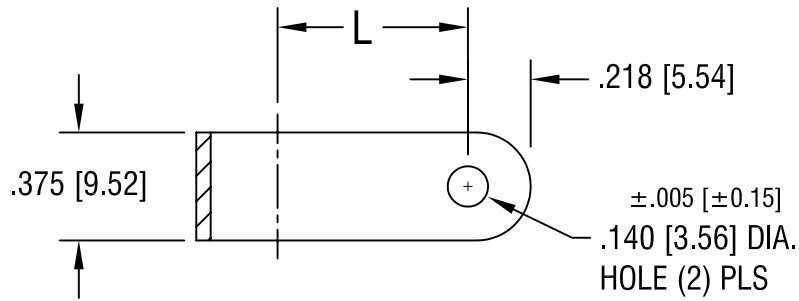

'L' DIM.	'D' FOR DIA.
.445 [11.30]	.312 [7.92]

KEYSTONE ELECTRONICS CORP.

ASTORIA, N.Y. 11105-2017

PART NAME

NYLON CABLE CLAMP

MATERIAL

.050 [1.27] TH'K NYLON 6/6

FINISH

-

DRN BY

BOONE

DATE

11.2.06

APP'D

LN

SCALE

NONE

TOLERANCES

INCH [MM]

CODE

DWG NO.

DECIMAL ± .015 [± 0.38]

C/M

ANGULAR ± 1°
UNLESS OTHERWISE SPECIFIED

7626

DATE

DESCRIPTION

REV.