

# CJ1W-NC□81/□82

## Preeminent control performance and easy operation feature of EtherCAT improve the production efficiency.

The EtherCAT communications with 100Mbps baud rate enables fast and accurate position control.

A wide range of position control functions are available with this position control unit.



Sysmac is a trademark or registered trademark of OMRON Corporation in Japan and other countries for OMRON factory automation products. Windows is either registered trademarks or trademarks of Microsoft Corporation in the United States and/or other countries. EtherCAT® is registered trademark and patented technology, licensed by Beckhoff Automation GmbH, Germany. Other company names and product names in this document are the trademarks or registered trademarks of their respective companies.

## Features

- Fast positioning operation: taking from 0.15 to 0.4ms (min.) to start servo operation from PLC start command.
- Support for Servomotors with Absolute Encoders
- Monitor the Deviation between Axes during Linear Interpolation
- A Wide Range of Positioning Operations
- Comes with Memory Operation function.
- Common control interface with pulse-train type position control unit (CJ1W-NC□□4).
- Fast communication of EtherCAT (250µs min. communications cycle).
- In addition to servo control, inverters, vision sensors, and other I/O devices that support EtherCAT can be connected.
- Support for Servomotors Speed Control and Torque limit outputs.
- A wide variety of Electronic Cam Synchronization applications (CJ1W-NC□82)

## System Configuration

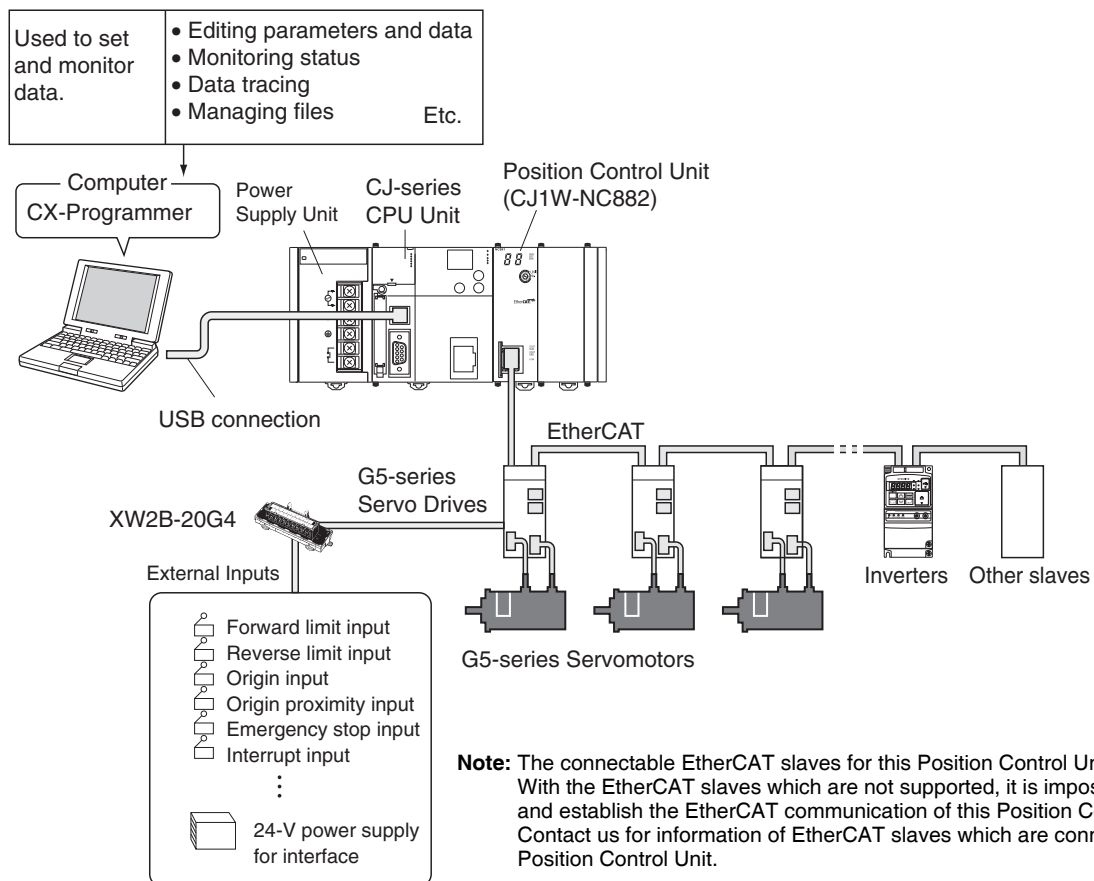

## Ordering Information

### International Standards

- The standards are abbreviated as follows: U: UL, U1: UL(Class I Division 2 Products for Hazardous Locations), C: CSA, UC: cULus, UC1: cULus (Class I Division 2 Products for Hazardous Locations), CU: cUL, N: NK, L: Lloyd, and CE: EC Directives.
- Contact your OMRON representative for further details and applicable conditions for these standards.

### Position Control Units with EtherCAT interface





Unit type	Product Name	Specifications		No. of unit numbers allocated	Current consumption (A)		Model	Standards
		Control output interface	No. of axes		5 V	24 V		
CJ1 CPU Bus Units	Position Control Units with EtherCAT interface	Control commands executed by EtherCAT communications. Positioning functions: Memory operation, Direct operation by ladder programming	2 axes	1	0.46	-	CJ1W-NC281	UC1, CE
			4 axes				CJ1W-NC481	
			8 axes				CJ1W-NC881	
			16 axes				CJ1W-NCF81	
		Control commands executed by EtherCAT communications. Positioning functions: Memory operation, Direct operation by ladder programming I/O communications: 64 nodes	4 axes	1	0.46	-	CJ1W-NC482	
			8 axes				CJ1W-NC882	
			16 axes				CJ1W-NCF82	

- Note:** 1. There is no accessory for the CJ-series Position Control Unit with EtherCAT interface.  
2. This unit cannot be used, with the Machine Automation Controller NJ-series.

### Recommended EtherCAT Communications Cables

Use Straight STP (shielded twisted-pair) cable of category 5 or higher with double shielding (braiding and aluminum foil tape) for EtherCAT.

### Cabel with Connectors

Item	Appearance	Recommended manufacturer	Cable length(m)	Model
Cable with Connectors on Both Ends (RJ45/RJ45) Standard RJ45 plugs type *1 Wire Gauge and Number of Pairs: AWG26, 4-pair Cable Cable Sheath material: LSZH *2 Cable color: Yellow *3		OMRON	0.3	XS6W-6LSZH8SS30CM-Y
			0.5	XS6W-6LSZH8SS50CM-Y
			1	XS6W-6LSZH8SS100CM-Y
			2	XS6W-6LSZH8SS200CM-Y
			3	XS6W-6LSZH8SS300CM-Y
			5	XS6W-6LSZH8SS500CM-Y
Cable with Connectors on Both Ends (RJ45/RJ45) Rugged RJ45 plugs type *1 Wire Gauge and Number of Pairs: AWG22, 2-pair Cable Cable color: Light blue		OMRON	0.3	XS5W-T421-AMD-K
			0.5	XS5W-T421-BMD-K
			1	XS5W-T421-CMD-K
			2	XS5W-T421-DMD-K
			5	XS5W-T421-GMD-K
			10	XS5W-T421-JMD-K
Cable with Connectors on Both Ends (M12 Straight/M12 Straight) Shield Strengthening Connector cable *4 M12/Smartclick Connectors Wire Gauge and Number of Pairs: AWG22, 2-pair Cable Cable color: Black		OMRON	0.5	XS5W-T421-BM2-SS
			1	XS5W-T421-CM2-SS
			2	XS5W-T421-DM2-SS
			3	XS5W-T421-EM2-SS
			5	XS5W-T421-GM2-SS
			10	XS5W-T421-JM2-SS
Cable with Connectors on Both Ends (M12 Straight/RJ45) Shield Strengthening Connector cable *4 M12/Smartclick Connectors Rugged RJ45 plugs type Wire Gauge and Number of Pairs: AWG22, 2-pair Cable Cable color: Black		OMRON	0.5	XS5W-T421-BMC-SS
			1	XS5W-T421-CMC-SS
			2	XS5W-T421-DMC-SS
			3	XS5W-T421-EMC-SS
			5	XS5W-T421-GMC-SS
			10	XS5W-T421-JMC-SS

- \*1. Standard type cables length 0.2, 0.3, 0.5, 1, 1.5, 2, 3, 5, 7.5, 10, 15 and 20 m are available.  
Rugged type cables length 0.3, 0.5, 1, 2, 3, 5, 10 and 15 m are available.  
For details, refer to Cat.No.G019.

\*2. The lineup features Low Smoke Zero Halogen cables for in-cabinet use and PUR cables for out-of-cabinet use. Although the LSZH cable is single shielded, its communications and noise characteristics meet the standards.

\*3. Cables colors are available in blue, yellow, or Green.

\*4. For details, contact your OMRON representative.

## Cables / Connectors

### Wire Gauge and Number of Pairs: AWG24, 4-pair Cable

Item	Appearance	Recommended manufacturer	Model
Cables	–	Hitachi Metals, Ltd.	NETSTAR-C5E SAB 0.5X4P *
	–	Kuramo Electric Co.	KETH-SB *
	–	SWCC Showa Cable Systems Co.	FAE-5004 *
RJ45 Connectors	–	Panduit Corporation	MPS588-C *

\* We recommend you to use above cable and connector together.

### Wire Gauge and Number of Pairs: AWG22, 2-pair Cable

Item	Appearance	Recommended manufacturer	Model
Cables	–	Kuramo Electric Co.	KETH-PSB-OMR *
	–	JMACS Japan Co., Ltd.	PNET/B *
RJ45 Assembly Connector		OMRON	XS6G-T421-1 *

**Note:** Connect both ends of cable shielded wires to the connector hoods.

\* We recommend you to use above cable and connector together.

## Support Software

Product name	Specifications			Model	Standards
		Number of licenses	Media		
<b>FA Integrated Tool Package CX-One Ver. 4.□</b>	The CX-One is a comprehensive software package that integrates Support Software for OMRON PLCs and components. CX-One runs on the following OS. OS: Windows XP (Service Pack 3 or higher, 32-bit version) / Windows Vista (32-bit/64-bit version) / Windows 7 (32-bit/64-bit version) / Windows 8 (32-bit/64-bit version) / Windows 8.1 (32-bit/64-bit version) / Windows 10 (32-bit/64-bit version) CX-One Version 4.□ includes CX-Programmer Ver.9.□. For details, refer to the CX-One catalog (Cat. No. R134).	1 license *	DVD	<b>CXONE-AL01D-V4</b>	–

\* Multi licenses (3, 10, 30, or 50 licenses) and DVD media without licenses are also available for the CX-One.

## Interpreting Model Numbers

You can identify the number of axes and output pattern from the model number.

### CJ1W-NC 2 8 1

(1)      (2) (3) (4)

No	Item	Symbol	Specifications
(1)	CJ-series Position Control Unit		
(2)	Number of axes	2	2 axes
		4	4 axes
		8	8 axes
		F	16 axes
(3)	Output pattern	8	EtherCAT
(4)	Development number	1	Servo control only
		2	Servo control + I/O communications

## Mountable Racks

Model	NJ system		CJ system (CJ1, CJ2)		CP1H system	NSJ system	
	CPU Rack	Expansion Rack	CPU Rack	Expansion Backplane	CP1H PLC	NSJ Controller	Expansion Backplane
CJ1W-NC281 CJ1W-NC481 CJ1W-NC881 CJ1W-NCF81 CJ1W-NC482 CJ1W-NC882 CJ1W-NCF82	Not Supported		16 Units max. (10 per Rack)		Not Supported	Not Supported	10 Units

## General Specifications

Item	CJ1W-NC281/NC481/NC881/NCF81/NC482/NC882/NCF82
Dimensions	90 × 65 × 31 mm (H × D × W)
Weight	110 g max.
Internal current consumption	460 mA max. at 5 VDC
Ambient operating temperature	0 to 55°C
Applicable standards	Conforms to cULus and EC Directives.

**Note:** All other specifications conform to the general specifications of the CJ Series.

# Characteristics

Item	Models							
	Servo control only				Servo control + I/O communications			
	CJ1W-NC281	CJ1W-NC481	CJ1W-NC881	CJ1W-NCF81	CJ1W-NC482	CJ1W-NC882	CJ1W-NCF82	
Applicable PLCs	CJ Series							
Settable unit numbers	0 to F (unit number as a CPU Bus Unit)							
Maximum number of Units	10 Units per Rack, 16 Units per PLC (Can be used on Expansion Racks.)							
Allocated I/O words	Position Control Unit Control Memory Areas	25 words in CPU Bus Unit Area						
	Axis Operation Memory Areas	43 words for each control axis (2 + 12 output words and 13 + 16 input words) in specified words in the CIO, Work, DM, or EM Area.						
	Memory Operation Memory Areas	7 words for each task (3 output words and 4 input words) in specified words in the CIO, Work, DM, or EM Area						
	I/O Memory Areas	---				1,300 words maximum (Outputs: 640 words, inputs: 640 words, communications status: 20 words) in specified words in the CIO, Work, DM, or EM Area		
Controllable Servo Drives *1	G5-series Servo Drives with Built-in EtherCAT Communications							
Controllable encoder input terminal *2 *3	---				OMRON encoder input terminal GX-EC02□1			
Control method	Control commands using EtherCAT communication							
Number of controlled axes	2 axes	4 axes	8 axes	16 axes	4 axes	8 axes	16 axes	
Maximum command output speed	104 Mpps *4							
Control units	Setting unit	Pulses, millimeters, inches, or degrees						
	Unit multiplier *5	×1, ×10, ×100, ×1,000, or ×10,000						
	Electronic gear ratio *5	Unit version 1.1 or earlier: 1/1 to 1,048,576/1,048,576 Unit version 1.3 or later: 1/1 to 4,294,967,295/4,294,967,295						
Positioning functions	Memory operation or direct operation							
Single axis control	Position control	2 axes	4 axes	8 axes	16 axes	4 axes	8 axes	16 axes
	Speed control	2 axes	4 axes	8 axes	16 axes	4 axes	8 axes	16 axes
Interpolated control	Linear interpolation	2 axes max.	4 axes max.	4 axes max.	4 axes max.	4 axes max.	4 axes max.	4 axes max.
	Circular interpolation	2 axes	2 axes	2 axes	2 axes	2 axes	2 axes	2 axes
	Helical interpolation *3	---	---	---	---	3 axes	3 axes	3 axes
Memory operation	Maximum number of tasks	2	4	4 *6	4 *6	4	4 *6	4 *6
	Sequence functions	JUMP, FOR-NEXT (50 layers/task), PSET, and PRSET						
	Dwell timers	500/task, 0 to 10.00 s (Set in increments of 0.01 s.)						
Position command values	Data	-2,147,483,648 to 2,147,483,647 command units *7						
	Number of position command values	500/task						
Speed command values	Data *8	Position control: 1 to 2,147,483,647 command units/s Speed control : -2,147,483,648 to 2,147,483,647 command units/s						
	Number of speed command values	500/task						
Acceleration times	Data	0 to 250,000 ms						
	Number of acceleration times	500/task						
Deceleration times	Data	0 to 250,000 ms						
	Number of deceleration times	500/task						
Auxiliary functions	Overrides	0.01% to 500.00% (Can be set for each axis.)						
	Software limits	-2,147,483,647 to 2,147,483,646 command units (Can be set for each axis.)						
	Backlash compensation	Backlash compensation is performed using the compensation function in the Servo Drive. The setting range depends on the specifications of the Servo Drive.						
	Torque Limits	Unit version 1.1 or earlier: Supports only the ability to enable or disable the torque limits by turning ON or OFF the command bits. Unit version 1.3 or later: Supports the ability to change the torque limit data via the Memory Area / Synchronous Data Link in addition to the ability to enable or disable the torque limits by turning ON or OFF the command bits.						
Synchronous Data Link function	None				Unit version 1.1 or earlier: None. Unit version 1.3 or later: Provides command support for velocity command data, torque command data, torque feedforward data, torque limit data, and velocity limitation value when used in conjunction with a CJ2H-CPU (unit version 1.4 or later). Unit version 1.5 or later: Provides command support for electronic cam operation.			

Item		Models							
		Servo control only				Servo control + I/O communications			
		CJ1W-NC281	CJ1W-NC481	CJ1W-NC881	CJ1W-NCF81	CJ1W-NC482	CJ1W-NC882	CJ1W-NCF82	
Control performance	Control cycle	0.5 ms	0.5 ms when using 1 to 2 axes 1 ms when using 3 to 4 axes	0.5 ms when using 1 to 2 axes 1 ms when using 3 to 4 axes 2 ms when using 5 to 8 axes	0.5 ms when using 1 to 2 axes 1 ms when using 3 to 4 axes 2 ms when using 5 to 16 axes	0.5 ms when using 1 to 2 axes 1 ms when using 3 to 4 axes	0.5 ms when using 1 to 2 axes 1 ms when using 3 to 4 axes 2 ms when using 5 to 8 axes	0.5 ms when using 1 to 2 axes 1 ms when using 3 to 4 axes 2 ms when using 5 to 16 axes	
	Communications cycle	250 μs		250 μs when using 1 to 4 axes 500 μs when using 5 to 8 axes	250 μs when using 1 to 4 axes 500 μs when using 5 to 10 axes 1.0 ms when using 11 to 16 axes	250 μs	250 μs when using 1 to 4 axes 500 μs when using 5 to 8 axes	250 μs min. when using 1 to 4 axes 500 μs min. when using 5 to 10 axes 1.0 ms when using 11 to 16 axes	
	Starting time *9	Direct operation (high-speed PTP) *10	0.15 to 0.4 ms		0.15 to 0.4 ms when using 1 to 4 axes 0.15 to 0.8 ms when using 5 to 8 axes	0.15 to 0.4 ms when using 1 to 4 axes 0.15 to 0.8 ms when using 5 to 10 axes 1.0 ms when using 11 to 16 axes	0.15 to 0.4 ms	0.15 to 0.4 ms when using 1 to 4 axes 0.15 to 0.8 ms when using 5 to 8 axes	0.15 to 0.4 ms when using 1 to 4 axes 0.15 to 0.8 ms when using 5 to 10 axes 1.0 ms when using 11 to 16 axes
		Direct operation (bits) *11	0.75 to 1.25 ms	1.25 to 2.25 ms	2.5 to 4.5 ms	3.0 to 5.0 ms	1.25 to 2.25 ms	2.5 to 4.5 ms	3.0 to 5.0 ms
Memory operation (linear interpolation) *11		1.75 to 2.25 ms	3.25 to 4.25 ms	6.5 to 8.5 ms	7.0 to 9.0 ms	3.25 to 4.25 ms	6.5 to 8.5 ms	7.0 to 9.0 ms	
Control I/O	Servo Drive interface	Communications port	EtherCAT port × 1						
		Output signals	There are no external output signals for external outputs. The following command bits are provided for each axis for Servo Drive control: Deviation Counter Reset Bit, Alarm Reset Bit, Servo Lock Bit, Servo Unlock Bit, and Torque Limit Bits.						
		Input signals	There are no external input signals for external inputs. The following status flags are provided for each axis for Servo Drive control: Origin Input Flag, Servo Drive Alarm Input Flag, and Positioning Completed Input Flag.						
		External interface signals *12	6 signals (external origin signal, origin proximity signal, forward limit signal, reverse limit signal, emergency stop signal, and interrupt input signal) for each axis						

\*1. A controllable Servo Drive is Servo Drive for which you can use the position control functions of the Position Control Unit.

\*2. A controllable encoder input terminal is a slave for which you can use the encoder axis function of the Position Control Unit.

\*3. Available with unit version 1.5 or later.

\*4. This is the maximum speed command when converted to pulses.

\*5. Command units can be set for each axis according to the electronic gear ratio and unit multiplier.

\*6. Up to four axes can be controlled by each task.

\*7. Setting is possible between -2,147,483,648 and 2,147,483,647 pulses.

\*8. The command can be set to up to 104,857,600 pps when converted to pulses.

\*9. This is the time from executing a command at the PLC until the command is output on EtherCAT communications.  
Execution for command bits is in the I/O refresh period.

The starting time depends on the control cycle, communications cycle, and operating conditions.

Refer to Position Control Units Operation Manual (Cat. No. W487) for details.

\*10. The starting time applies when starting one axis with a special Position Control Unit instruction and a CJ2M or CJ2H CPU Unit with unit version 1.3 or later.

\*11. These are the internal Position Control Unit processing times.

\*12. Servo Drive inputs are used.

## EtherCAT Communications Specifications

Item	Characteristics						
	Servo control only				Servo control + I/O communications		
	CJ1W-NC281	CJ1W-NC481	CJ1W-NC881	CJ1W-NCF81	CJ1W-NC482	CJ1W-NC882	CJ1W-NCF82
Communications standard	IEC 61158 Type12						
Physical layer	100Base-TX (IEEE802.3)						
Connector	RJ45 shielded connector × 1						
Communications media	Category 5 or higher (Recommended: cable with double, aluminum tape and braided shielding)						
Communications distance	100 m max. between nodes						
Topology	Daisy chain only *1						
EtherCAT Master Specifications	Class B (minimum master-CoE compatible (no information service for SDO))						
Maximum number of slaves *2	2	4	8	16	68	72	80
Node address setting range	1 to 2	1 to 4	1 to 8	1 to 16	1 to 4 and 17 to 80 *3	1 to 8 and 17 to 80 *3	1 to 16 and 17 to 80 *3
Communications cycle *4	250 μs, 500 μs, 1 ms, or 2 ms						
Process data	Fixed PDO mappings specified for the slaves are used (set using Support Software).						
Mail box (CoE)	Emergency messages, SDO requests, SDO responses, and SDO information (Used for Position Control Unit communications control and slave device parameter transfers.)						
LED indicators	ECAT RUN × 1 ECAT ERR × 1 L/A (Link/Activity) × 1						
CiA402 drive profile *5	<ul style="list-style-type: none"> <li>• Cyclic synchronous position mode</li> <li>• Cyclic synchronous velocity mode</li> <li>• Cyclic synchronous torque mode</li> <li>• Touch probe function</li> <li>• Torque limit function</li> </ul>						

\*1. Ethernet hubs cannot be used.

\*2. This is the number of slaves, including Servo Drives and remote I/O slaves. The number of slaves that can be connected is limited. Refer to *Number of Remote I/O Connections* for details.

\*3. Node addresses 17 to 80 are reserved for remote I/O slaves.

\*4. The setting range depends on the number of slaves that are connected and the slave specifications. Refer to Position Control Units Operation Manual (Cat. No. W487) for details.

\*5. This drive profile is used when connected to a G5-series Servo Drive.

### Number of Remote I/O Connections

The Position Control Unit has the memory of up to 640 bytes for inputs and 640 bytes for outputs to be used for PDO communications. The number of slaves that can be connected to the CJ1W-NC482/NC882/NCF82 is determined by the maximum memory size for PDO communications. The memory of the PDO communication is shared with the Servo Drives; therefore, the number of I/O slaves that can be connected changes with the number of G5 Series Servo Drive (number of use axes) that are connected to the Position Control Unit.

Number of Servo Drive axes	Size used by Servo Drive axes (bytes) *	Remaining PDO communications memory size (bytes)		Number of slaves that can be connected according to slave I/O size (guidelines)			
		IN	OUT	8 bytes of I/O (4 input and 4 output bytes)	16 bytes of I/O (8 input and 8 output bytes)	32 bytes of I/O (16 input and 16 output bytes)	64 bytes of I/O (32 input and 32 output bytes)
0 axis	0	640	640	64	64	40	20
1 axis	29	611	611	64	64	38	19
2 axes	58	582	582	64	64	36	18
4 axes	116	524	524	64	64	32	16
8 axes	232	408	408	64	51	25	12
16 axes	464	176	176	64	22	11	5

\* The G5-series Servo Drives also use IN and OUT bytes. The factory default of the PDO communications size is 29 bytes.

## Functional Specifications

The following functions are supported when the Position Control Unit is connected to an EtherCAT-compatible OMNUC G5-series Servo Drive.

Function		Description	
Control functions	Single axis control	<b>Absolute movements</b>	Positioning is performed by specifying the absolute or relative target position and target speed directly from the ladder program.
		<b>Relative movements</b>	
		<b>Speed control</b>	Feeding at a specified speed is performed by specifying the target speed directly from the ladder program. Speed control is implemented using speed feeding with position control.
		<b>Interrupt feeding</b>	Interrupt feeding can be used to move a specified amount when an interrupt input is received during an absolute movement, a relative movement, or speed control.
		<b>Rotation axis control</b>	Rotation axes that are suitable for feeder and index table control can be controlled. Forward and reverse positioning and shortest route operations are possible.
	Multi-axis control	<b>Changing target positions and target speeds</b>	The target position or target speed can be changed during an absolute movement, a relative movement, or speed control.
		<b>Linear interpolation</b>	The operation of more than one axis is started and stopped simultaneously to move in a straight line to the target position from the starting point of each axis. Linear interpolation is possible for up to four axes.
		<b>Circular interpolation</b>	The operation of any two axes is controlled to move in a circular arc. Any of three methods can be used to specify a circular arc: specifying the target position and center point, specifying the target position, radius, and direction and specifying the target position and passing point.
	Memory operation	<b>Helical interpolation</b>	Helical interpolation is performed by giving one more axis to circular interpolation. The number of turns can be specified. This function is available with CJ1W-NC□82 (unit version 1.5 or later).
		<b>Automatic continuous operation</b>	The target positions, speeds, and operation patterns can be set in advance in the Position Control Unit to automatically perform a series of operations. Continuous positioning and speed changes are also possible.
Manual operation	<b>Sequence functions</b>	Memory operation data provides sequence functions, including repetition of a given operation and starting/stopping operation data by using external inputs. Therefore, the Position Control Unit can perform various operation sequences without affecting the ladder programming in the CPU Unit.	
	<b>Origin searches</b>	External sensors and other means are used to detect the mechanical origin of the system. You can select the origin search operation that is best for your system from 15 different origin search operation patterns.	
	<b>Origin returns</b>	You can return to the point that was defined as the mechanical origin.	
	<b>Presetting the present position</b>	The present position can be changed to a specified value to define the origin.	
	<b>Deceleration stops and emergency stops</b>	An axis that is in operation can be decelerated to a stop or stopped immediately.	
	<b>Jogging</b>	You can jog either forward or in reverse.	
Synchronous Data Link	<b>Inching</b>	You can inch either forward or in reverse.	
		The CJ1W-NC□82 (unit version 1.3 or later) can perform data exchange between the CPU and Position Control Unit at regular intervals when used in conjunction with a CJ2H CPU (unit version 1.4 or later). In addition, you can use this function to perform synchronous feeding position, synchronous feeding velocity, and synchronous feeding torque control. Also, optional commands are available for torque feedforward data, torque limit data, and velocity limitation value. CJ1W-NC□82 (unit version 1.5 or later) supports command for electronic cam operation as well.	
Auxiliary control functions	<b>Command unit setting</b>	You can set the unit of control for each axis according to the machine.	
	Acceleration/deceleration control	<b>Automatic acceleration/deceleration control</b>	The acceleration/deceleration curve can be automatically created during operation. You can select either a trapezoidal curve or an S curve based on a tertiary function.
		<b>Changing acceleration/deceleration rates</b>	You can change the rate of acceleration/deceleration during acceleration/deceleration.
		<b>Switching acceleration/deceleration points</b>	You can select one of three methods to connect speeds between different operation patterns during continuous memory operation.
	<b>Overrides</b>	You can increase or decrease the operating speed of the system by a specified factor.	
	<b>Backlash compensation</b>	You can compensate for mechanical play using a parameter.	
	<b>M codes</b>	M codes can be output during memory operation to interlock with external devices.	
	<b>Zone settings</b>	You can set zones and assess when the present position is in a zone. Up to three zones can be set for each axis.	
	<b>Support for absolute encoders</b>	You can build an absolute positioning system by using a Servomotor with an Absolute Encoder. The Position Control Units can be used together with OMRON's G5-series Servomotors with Absolute Encoders.	
	<b>Teaching</b>	You can save the present position as position data for memory operation. You can use either the command present position or feedback present position.	
	<b>Torque limit outputs</b>	The torque limit outputs can be used to switch the torque limits of the Servo Drive. They can be turned ON and OFF directly from a ladder program. Torque limits can be automatically switched by using holding for an origin search operation. In addition, you can change the torque limit data via the Synchronous Data Link by using the CJ1W-NC□82 (unit version 1.3 or later) in conjunction with a CJ2H-CPU (unit version 1.4 or later) and G5-series Servo Drive (version 2.0 or later). Also, you can change the torque limit data via the Memory Area by using the CJ1W-NC□81/ -NC□82 (unit version 1.3 or later) in conjunction with a G5-series Servo Drive (version 2.0 or later).	
	Monitoring functions	<b>Software limits</b>	You can set forward and reverse software limits for axis operation. If the target position exceeds a software limit, it will be detected in the command value check that is performed at startup.
<b>Monitoring position/speed deviations</b>		The Position Control Unit monitors the position or speed deviation between the present command position and present feedback position. You can stop axis operation if the deviation is too large.	
<b>Monitoring deviation between axes</b>		The deviation between axes is also monitored during linear interpolation. You can stop axis operation if the deviation is too large.	



Functions available when connected with OMRON encoder input terminal GX-EC02□1 are as shown below.  
They are available with CJ1W-NC□82, unit version 1.5 or later.

Function		Description
Manual operation	Present position preset	The present position can be changed to a specified value to define the origin.
	Command unit setting	You can set the unit of control for each axis according to the machine.
Auxiliary control functions	Zone settings	You can set a zone to check if the present position is in the set zone. Up to three zones can be set for each axis.
	Present position latch	The position data when an external control input (latch A) is detected at the encoder input terminal is stored in the Position Control Unit.
	Origin position latch	The position data when an external control input (latch B) is detected at the encoder input terminal is stored in the Position Control Unit.

## External Interface

### Part Names

CJ1W-NC281/-NC481/-NC881/-NCF81/-NC482/-NC882/-NCF82

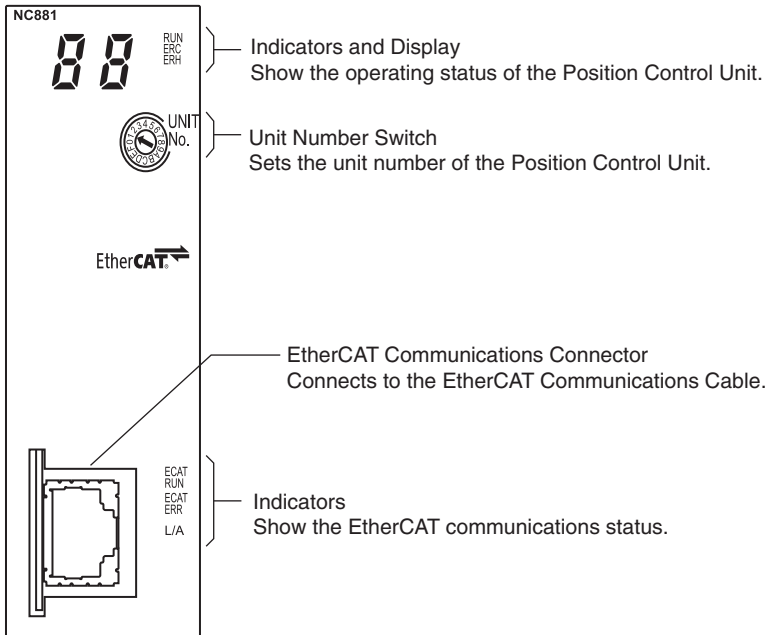

### Indicators

Indicator	Display color	Status	Description
RUN	Green	ON	Normal operation.
		OFF	The power supply is OFF, a hardware error has occurred, or the PLC has detected a Position Control Unit error.
ERC	Red	ON	An error has occurred.
		OFF	Other than the above
ERH	Red	ON	There is an error in the PLC.
		OFF	Other than the above
ECAT RUN	Green	OFF	Initialized state
		Blinking	Pre-Operational state
		Single flash	Safe-Operational state
		ON	Operational state
ECAT ERR	Red	OFF	No error
		Blinking	Communications setting error
		Single flash	Synchronization error or communications data error
		Double flash	Application WDT timeout
		Flickering	Boot error
ECAT L/A	Green	ON	PDI WDT timeout
		OFF	Link not established in physical layer.
		ON	Link established in physical layer.
		Flickering	In operation after establishing link.

## EtherCAT Communications Connector

This connector is used to connect the EtherCAT twisted-pair cable.

### Connector Specifications

Specification	Description
Electrical characteristics	Conforms to IEEE 802.3 standards.
Connector structure	RJ45 8-pin modular connector (Conforms to ISO 8877.)

### Pin Assignments

	Pin No.	Signal name	Abbreviation	Signal direction
	1	Transmission data +	TD+	Output
	2	Transmission data -	TD-	Output
	3	Reception data +	RD+	Input
	4	Not used.	---	---
	5	Not used.	---	---
	6	Reception data -	RD-	Input
	7	Not used.	---	---
	8	Not used.	---	---
	Hood	Frame ground	FG	---

### EtherCAT Communications Cables

Use a category 5 or higher cable with double, aluminum tape and braided shielding.

**Note:** The maximum distance between any two nodes is 100 m. Some cables, however, are not rated for 100 m. Generally speaking, the transmission performance of stranded wires is worse than that of solid wire. Cables with stranded wires generally are not rated for 100 m.

### Connector (Modular Plug) Specifications

Use a category 5 or higher, shielded connector.

**Note:** When selecting a connector, make sure that it is suitable for the cable that you are using. The following items must be confirmed: conductor size, whether connector is solid or stranded wire, whether there are 2 wire pairs or 4, the outside diameter, etc.

## Unit Versions and Programming

### Unit Versions

○: Exist, ---: Does not exist

Unit	Model	Unit Versions					
		Ver. 1.0	Ver. 1.1	Ver. 1.3	Ver. 1.4	Ver. 1.5	Ver. 1.6
Position Control Units with EtherCAT	CJ1W-NC281	○	○	○	○	○	○
	CJ1W-NC481	○	○	○	○	○	○
	CJ1W-NC881	○	○	○	○	○	○
	CJ1W-NCF81	---	○	○	○	○	○
	CJ1W-NC482	---	○	○	○	○	○
	CJ1W-NC882	---	○	○	○	○	○
	CJ1W-NCF82	---	---	○	○	○	○
Compatible CX-Programmer version		Version 9.11 or higher	Version 9.12 or higher	Version 9.32 or higher	Version 9.52 or higher *	Version 9.60 or higher	Version 9.65 or higher

\* Check *CX-One Information*. The Common Components must be 2014.09 (September 2014) or later.

## Function Support According to Unit Versions

CJ1W-NC□81

○: Supported, ---: Not supported

Function	Unit Versions					
	Ver. 1.0	Ver. 1.1	Ver. 1.3	Ver. 1.4	Ver. 1.5	Ver. 1.6 *3
Status Word Expanded Monitor Type	---	○	○	○	○	○
I/O communications as type of slave that can be connected	---	○	○	○	○	○
Enabling/disabling registered slaves	---	○	○	○	○	○
Clearing input data to zero when there is a communications error with a remote I/O slave	---	○	○	○	○	○
Electronic gear ratio setting range expansion	---	---	○	○	○	○
Origin position latch	---	---	○	○	○	○
Ad hoc change of torque limit data using Allocated Memory Areas *1	---	---	○	○	○	○
Ad hoc change of torque limit data/torque feedforward data using the Synchronous Data Link *1 *2	---	---	---	---	---	---
Synchronous Data Link (Electric Shaft function) *1 *2	---	---	---	---	---	---
Synchronous Data Link (Synchronous feeding velocity function) *1 *2	---	---	---	---	---	---
Synchronous Data Link (Synchronous feeding torque function) *1 *2	---	---	---	---	---	---
Absolute Encoder Origin Establishment Timing Setting	---	---	---	○	○	○
Electronic cam operation	---	---	---	---	---	---
Encoder axis	---	---	---	---	---	---
Helical interpolation	---	---	---	---	---	---

\*1. Whether or not this function is supported depends on the version of the G5-series Servo Drive.

For details, refer to "Function Support According to G5-series Servo Drive Versions".

\*2. Whether or not this function is supported depends on the version of the G5-series Servo Drive.

For details, refer to "Function Support According to CPU Unit Versions".

\*3. Connectable slaves are added. Other functions are the same as the functions available in unit version 1.5.

CJ1W-NC□82

○: Supported, ---: Not supported

Function	Unit Versions					
	Ver. 1.0	Ver. 1.1	Ver. 1.3	Ver. 1.4	Ver. 1.5	Ver. 1.6 *3
Status Word Expanded Monitor Type	---	○	○	○	○	○
I/O communications as type of slave that can be connected	---	○	○	○	○	○
Enabling/disabling registered slaves	---	○	○	○	○	○
Clearing input data to zero when there is a communications error with a remote I/O slave	---	○	○	○	○	○
Electronic gear ratio setting range expansion	---	---	○	○	○	○
Origin position latch	---	---	○	○	○	○
Ad hoc change of torque limit data using Allocated Memory Areas *1	---	---	○	○	○	○
Ad hoc change of torque limit data/torque feedforward data using the Synchronous Data Link *1 *2	---	---	○	○	○	○
Synchronous Data Link (Electric Shaft function) *1 *2	---	---	○	○	○	○
Synchronous Data Link (Synchronous feeding velocity function) *1 *2	---	---	○	○	○	○
Synchronous Data Link (Synchronous feeding torque function) *1 *2	---	---	○	○	○	○
Absolute Encoder Origin Establishment Timing Setting	---	---	---	○	○	○
Electronic cam operation	---	---	---	---	○	○
Encoder axis	---	---	---	---	○	○
Helical interpolation	---	---	---	---	○	○

\*1. Whether or not this function is supported depends on the version of the G5-series Servo Drive.

For details, refer to "Function Support According to G5-series Servo Drive Versions".

\*2. Whether or not this function is supported depends on the version of the G5-series Servo Drive.

For details, refer to "Function Support According to CPU Unit Versions".

\*3. Connectable slaves are added. Other functions are the same as the functions available in unit version 1.5.

## Function Support According to G5-series Servo Drive Versions

As indicated in the table below, functions supported by CJ1W-NC□82 Position Control Units (unit version 1.3 or later) differ depending on the version of the G5 series servo drive used in conjunction with the Position Control Unit:

○: Supported, ---: Not supported

Function	Drive version		
	Ver. 1.□	Ver. 2.0 or later	
Synchronous Data Link function (Synchronous feeding functions)	Synchronous Feeding Position (Electric Shaft) function	○	○
	Synchronous Feeding Velocity function	---	○
	Synchronous Feeding Torque function	---	○
Ad hoc change of torque limit data by use of Allocated Memory Areas		---	○
Ad hoc change of torque limit data / torque feedforward data by use of the Synchronous Data Link		---	○

## Function Support According to CPU Unit Versions

As indicated in the table below, functions supported by CJ1W-NC□82 Position Control Units (unit version 1.3 or later) differ depending on the version of the CPU unit used in conjunction with the Position Control Unit:

○: Supported, Δ: Limited, ---: Not supported

Function	CJ2H		CJ1-H/CJ1/ CJ1M/CJ2M	
	Ver. 1.3 or earlier	Ver. 1.4 or later		
Synchronous Data Link function (Synchronous feeding functions)	Synchronous Feeding Position (Electric Shaft) function *	Δ*	○	Δ*
	Electronic cam operation	Δ*	○	Δ*
	Synchronous Feeding Velocity function	---	○	---
	Synchronous Torque Command function	---	○	---
Ad hoc change of torque limit data / torque feedforward data by use of the Synchronous Data Link		---	○	---

\* Available with CJ1W-NC□82, unit version 1.5 or later. Note that Synchronous Data Link output cannot be set as an auxiliary axis. If it is set, the value of auxiliary axis will always be 0.

## Function List of Function Block Library (FBL)

### Omron FB (Function Block Library)

1	Move Absolute	14	Read Status
2	Unlimited Move Absolute	15	Read Parameter
3	Move Relative	16	Read Error
4	Speed Control	17	Read Present Position
5	Origin Search	18	Present Position Latch
6	Origin Return	19	Write Parameter
7	Deceleration Stop	20	Save Parameter
8	Operation Command	21	Teaching
9	Error Reset	22	Present Position Preset
10	Deviation Counter Reset	23	Override Setting
11	Run Program	24	Torque Limits
12	Interrupt Feeding	25	Absolute Encoder Setup
13	Jogging / Inching	26	Absolute Encoder's Origin Position Offset Setting

## Dimensions

(Unit: mm)

### CJ1W-NC281/-NC481/-NC881/-NCF81/-NC482/-NC882/-NCF82

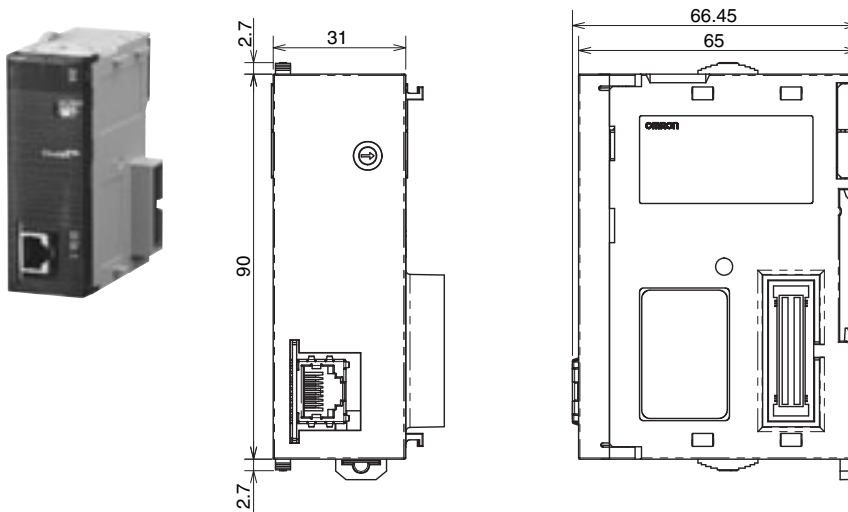

## Related Manuals

Manual	Cat. No.	Model	Application	Description
CJ-series Position Control Unit Operation Manual	W487	CJ1W-NC281 CJ1W-NC481 CJ1W-NC881 CJ1W-NCF81 CJ1W-NC482 CJ1W-NC882 CJ1W-NCF82	Information on CJ1W-NC281/-NC481/-NC881/-NCF81/-NC482/-NC882/-F82 Position Control Units	Describes the setting and application procedures for the Position Control Units.
CX-Programmer Operation Manual	W446	CXONE-AL□□C-V□ /-AL□□D-V□	Support Software for Windows computers CX-Programmer operating procedure	Describes operating procedures for the CX-Programmer.

## Terms and Conditions Agreement

### Read and understand this catalog.

Please read and understand this catalog before purchasing the products. Please consult your OMRON representative if you have any questions or comments.

### Warranties.

(a) Exclusive Warranty. Omron's exclusive warranty is that the Products will be free from defects in materials and workmanship for a period of twelve months from the date of sale by Omron (or such other period expressed in writing by Omron). Omron disclaims all other warranties, express or implied.

(b) Limitations. OMRON MAKES NO WARRANTY OR REPRESENTATION, EXPRESS OR IMPLIED, ABOUT NON-INFRINGEMENT, MERCHANTABILITY OR FITNESS FOR A PARTICULAR PURPOSE OF THE PRODUCTS. BUYER ACKNOWLEDGES THAT IT ALONE HAS DETERMINED THAT THE PRODUCTS WILL SUITABLY MEET THE REQUIREMENTS OF THEIR INTENDED USE.

Omron further disclaims all warranties and responsibility of any type for claims or expenses based on infringement by the Products or otherwise of any intellectual property right. (c) Buyer Remedy. Omron's sole obligation hereunder shall be, at Omron's election, to (i) replace (in the form originally shipped with Buyer responsible for labor charges for removal or replacement thereof) the non-complying Product, (ii) repair the non-complying Product, or (iii) repay or credit Buyer an amount equal to the purchase price of the non-complying Product; provided that in no event shall Omron be responsible for warranty, repair, indemnity or any other claims or expenses regarding the Products unless Omron's analysis confirms that the Products were properly handled, stored, installed and maintained and not subject to contamination, abuse, misuse or inappropriate modification. Return of any Products by Buyer must be approved in writing by Omron before shipment. Omron Companies shall not be liable for the suitability or unsuitability or the results from the use of Products in combination with any electrical or electronic components, circuits, system assemblies or any other materials or substances or environments. Any advice, recommendations or information given orally or in writing, are not to be construed as an amendment or addition to the above warranty.

See <http://www.omron.com/global/> or contact your Omron representative for published information.

### Limitation on Liability: Etc.

OMRON COMPANIES SHALL NOT BE LIABLE FOR SPECIAL, INDIRECT, INCIDENTAL, OR CONSEQUENTIAL DAMAGES, LOSS OF PROFITS OR PRODUCTION OR COMMERCIAL LOSS IN ANY WAY CONNECTED WITH THE PRODUCTS, WHETHER SUCH CLAIM IS BASED IN CONTRACT, WARRANTY, NEGLIGENCE OR STRICT LIABILITY.

Further, in no event shall liability of Omron Companies exceed the individual price of the Product on which liability is asserted.

### Suitability of Use.

Omron Companies shall not be responsible for conformity with any standards, codes or regulations which apply to the combination of the Product in the Buyer's application or use of the Product. At Buyer's request, Omron will provide applicable third party certification documents identifying ratings and limitations of use which apply to the Product. This information by itself is not sufficient for a complete determination of the suitability of the Product in combination with the end product, machine, system, or other application or use. Buyer shall be solely responsible for determining appropriateness of the particular Product with respect to Buyer's application, product or system. Buyer shall take application responsibility in all cases.

NEVER USE THE PRODUCT FOR AN APPLICATION INVOLVING SERIOUS RISK TO LIFE OR PROPERTY OR IN LARGE QUANTITIES WITHOUT ENSURING THAT THE SYSTEM AS A WHOLE HAS BEEN DESIGNED TO ADDRESS THE RISKS, AND THAT THE OMRON PRODUCT(S) IS PROPERLY RATED AND INSTALLED FOR THE INTENDED USE WITHIN THE OVERALL EQUIPMENT OR SYSTEM.

### Programmable Products.

Omron Companies shall not be responsible for the user's programming of a programmable Product, or any consequence thereof.

### Performance Data.

Data presented in Omron Company websites, catalogs and other materials is provided as a guide for the user in determining suitability and does not constitute a warranty. It may represent the result of Omron's test conditions, and the user must correlate it to actual application requirements. Actual performance is subject to the Omron's Warranty and Limitations of Liability.

### Change in Specifications.

Product specifications and accessories may be changed at any time based on improvements and other reasons. It is our practice to change part numbers when published ratings or features are changed, or when significant construction changes are made. However, some specifications of the Product may be changed without any notice. When in doubt, special part numbers may be assigned to fix or establish key specifications for your application. Please consult with your Omron's representative at any time to confirm actual specifications of purchased Product.

### Errors and Omissions.

Information presented by Omron Companies has been checked and is believed to be accurate; however, no responsibility is assumed for clerical, typographical or proofreading errors or omissions.