

**Pb-free  
HEAT**



# G□□3801C

φ3 Flush Mount Type LED

## Features

Package	φ3 Flush Mount Type. Water clear resin	
Product features	<ul style="list-style-type: none"> <li>• Outer Dimension φ3 Flush Mount Type.</li> <li>• Low power consumption type</li> <li>• Operation temperature range Storage Temperature Operating Temperature</li> <li>• Lead-free soldering compatible</li> <li>• RoHs compliant</li> </ul>	
Chromaticity coordinates	x = 0.31TYP., y = 0.32TYP. (GSW)	
Dominant wavelength	Blue	: 470nm(GSB)
	Green	: 530nm(GSG)
Spatial distribution	GSW	: 40deg.
	GSB	: 30deg.
	GSG	: 30deg.
Die materials	InGaN	
Rank grouping parameter	Sorted by luminous intensity rank and chromaticity rank (GSW) Sorted by luminous intensity rank (GSB, GLG)	
Soldering methods	TTW (Through The Wave) soldering and manual soldering	
ESD-withstand voltage	Up to 1kV (HBM)	
Packing	Bulk : 200pcs(MIN.)	

## Recommended Applications

Amusement Equipment, OA/FA, Other General Applications

**Color and Luminous Intensity**

(Ta=25°C)

Part No.	Material	Emitted Color	Lens Color	Chromaticity Coordinates x,y		Dominant Wavelength λd (nm)		Luminous Intensity Iv (mcd)		
				TYP.	IF (mA)	TYP.	IF (mA)	MIN.	TYP.	IF (mA)
GSW3801C	InGaN	White	Water Clear	0.31,0.32	5	—	—	800	1,600	5
GSB3801C		Blue		—	—	470	5	600	1,200	5
GSG3801C		Green		—	—	530	5	1,400	3,500	5

## Absolute Maximum Ratings

(Ta=25°C)

Item	Symbol	Absolute Maximum Ratings			Unit
		GSW	GSB	GSG	
Power Dissipation	$P_d$	36	36	38	mW
Forward Current	$I_F$	10	10	10	mA
Pulse Forward Current ※1	$I_{FRM}$	20	20	20	mA
Derating (Ta=25°C or higher)	$\Delta I_F$	0.133	0.133	0.133	mA/°C
	$\Delta I_{FRM}$	0.267	0.267	0.267	mA/°C
Reverse Voltage	$V_R$	5			V
Operating Temperature	$T_{opr}$	-40~+85			°C
Storage Temperature	$T_{stg}$	-40~+100			°C

 ※1  $I_{FRM}$  Measurement condition : Pulse Width 1ms., Duty 1/20.

## Electro-Optical Characteristics

(Ta=25°C)

Item	Condition	Symbol	Characteristics				Unit
				GSW	GSB	GSG	
Forward Voltage	$I_F=5mA$	$V_F$	TYP.	2.9	3.0	3.0	V
			MAX.	3.3	3.5	3.5	
Reverse Current	$V_R=5V$	$I_R$	MAX.	100	100	100	μA
Chromaticity Coordinates	$I_F=5mA$	x	TYP.	0.31	-	-	-
		y	TYP.	0.32	-	-	-
Peak Wavelength	$I_F=5mA$	$\lambda_p$	TYP.	-	465	520	nm
Dominant Wavelength	$I_F=5mA$	$\lambda_d$	TYP.	-	470	530	nm
Spectral Line Half Width	$I_F=5mA$	$\Delta\lambda$	TYP.	-	25	40	nm
Half Intensity Angle	$I_F=5mA$	2θ1/2	TYP.	40	30	30	deg.

**Luminous Intensity Rank**

(Ta=25°C)

Rank	I <sub>V</sub> (mcd)					
	GSW		GSB		GSG	
	I <sub>F</sub> =5mA		I <sub>F</sub> =5mA		I <sub>F</sub> =5mA	
	MIN.	MAX.	MIN.	MAX.	MIN.	MAX.
<b>A</b>	<b>800</b>	<b>1,600</b>	<b>600</b>	<b>1,200</b>	<b>1,400</b>	<b>2,800</b>
<b>B</b>	<b>1,120</b>	<b>2,240</b>	<b>840</b>	<b>1,680</b>	<b>2,000</b>	<b>4,000</b>
<b>C</b>	<b>1,600</b>	<b>3,200</b>	<b>1,200</b>	<b>2,400</b>	<b>2,800</b>	<b>5,600</b>
<b>D</b>	<b>2,240</b>	<b>4,480</b>	<b>1,680</b>	<b>3,340</b>	<b>4,000</b>	<b>8,000</b>
<b>E</b>	<b>3,200</b>	<b>-</b>	<b>2,400</b>	<b>-</b>	<b>5,600</b>	<b>-</b>

※Please contact our sales staff concerning rank designation.

**Sorting Chart for Chromaticity Coordinates (GSW)**

(Ta=25°C)

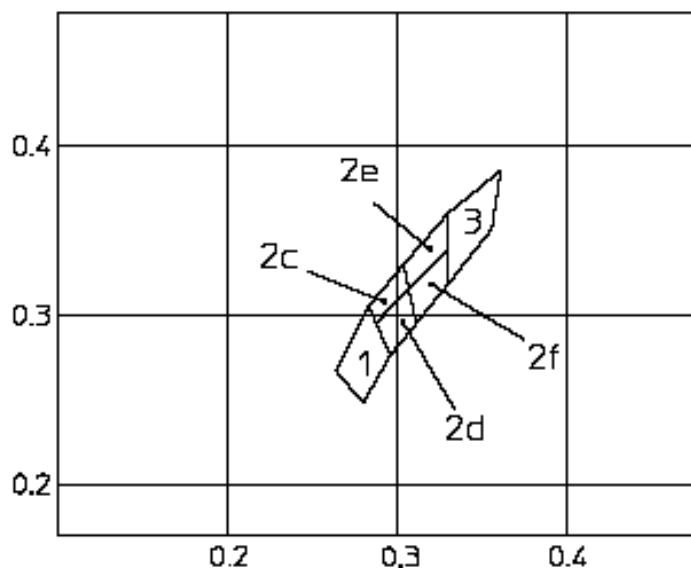
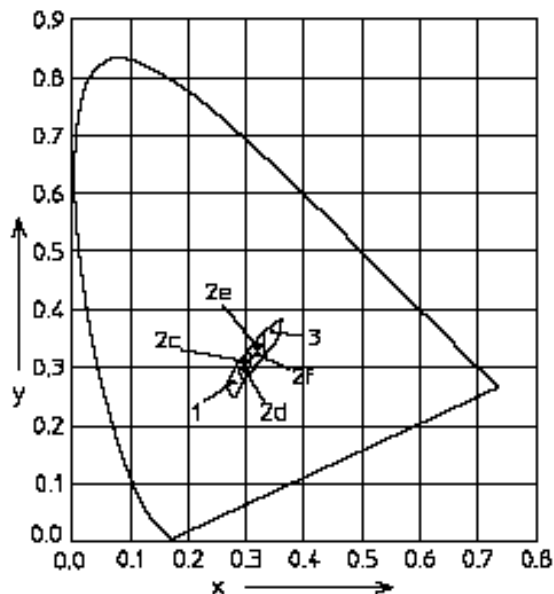

Rank	LEFT DOWN point		LEFT UP point		RIGHT UP point		RIGHT UP point		Conditions
	x	y	x	y	x	y	x	y	
1	0.280	0.248	0.264	0.267	0.283	0.305	0.296	0.276	If =5mA
2c	0.287	0.295	0.283	0.305	0.304	0.330	0.307	0.315	
2d	0.296	0.276	0.287	0.295	0.307	0.315	0.311	0.294	
2e	0.307	0.315	0.304	0.330	0.330	0.360	0.330	0.339	
2f	0.311	0.294	0.307	0.315	0.330	0.339	0.330	0.318	
3	0.330	0.318	0.330	0.360	0.361	0.385	0.356	0.351	

Chromaticity Coordinates Tolerance Each Rank : +/-0.02

※Please contact our sales staff concerning rank designation.

## Technical Data (GSW)

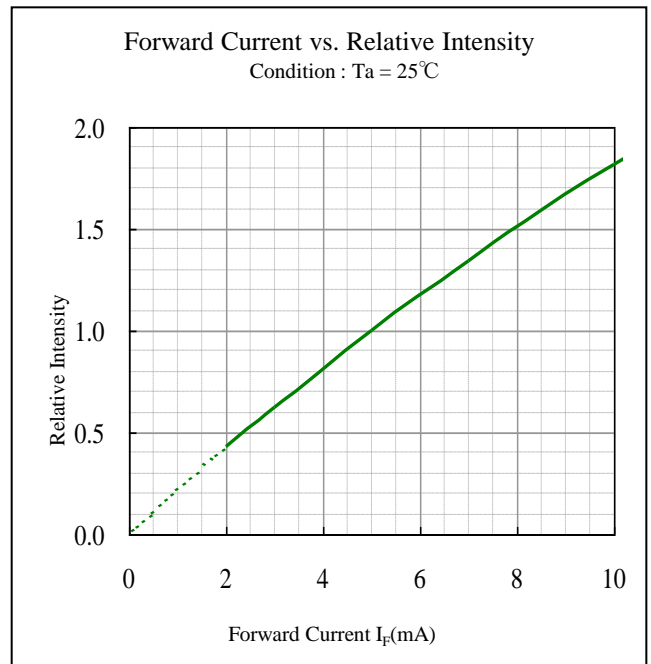
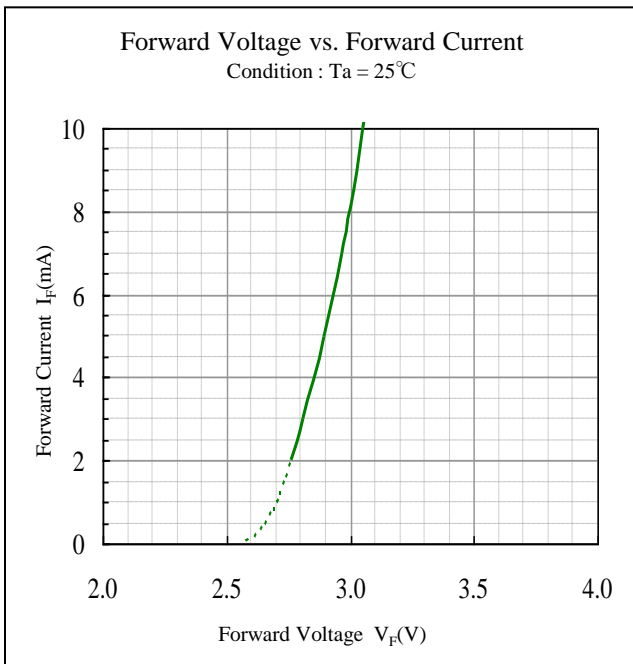
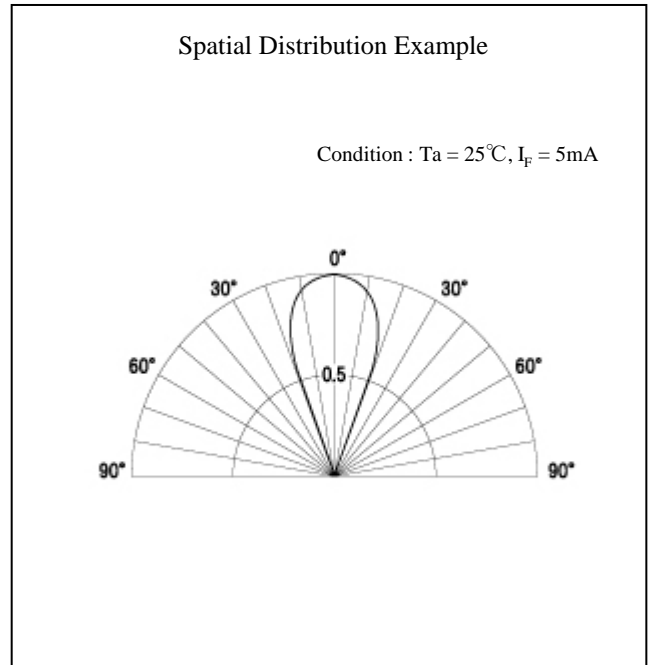
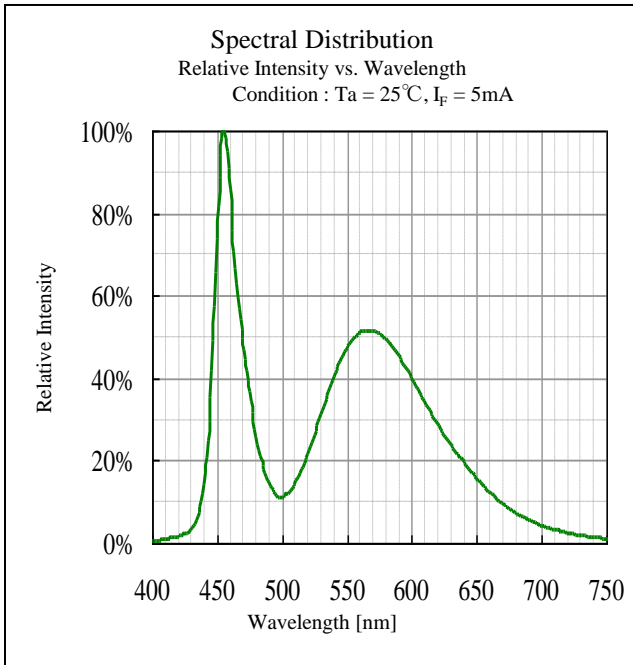

## Technical Data (GSW)

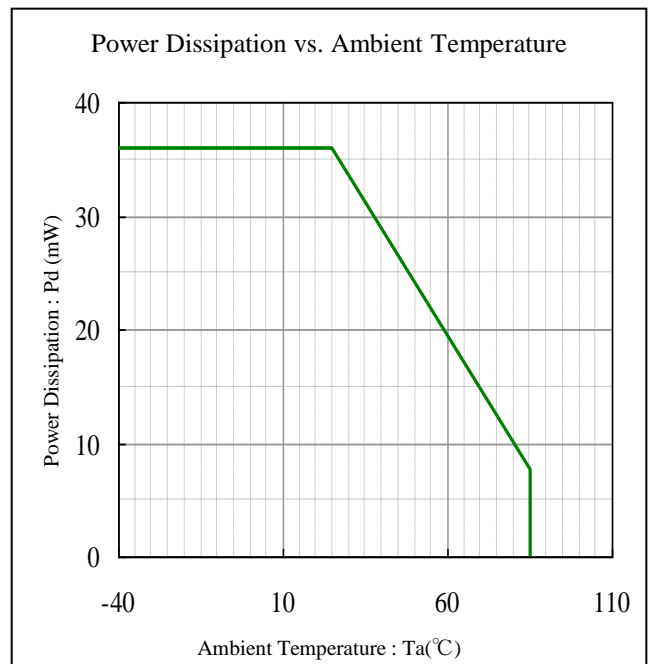
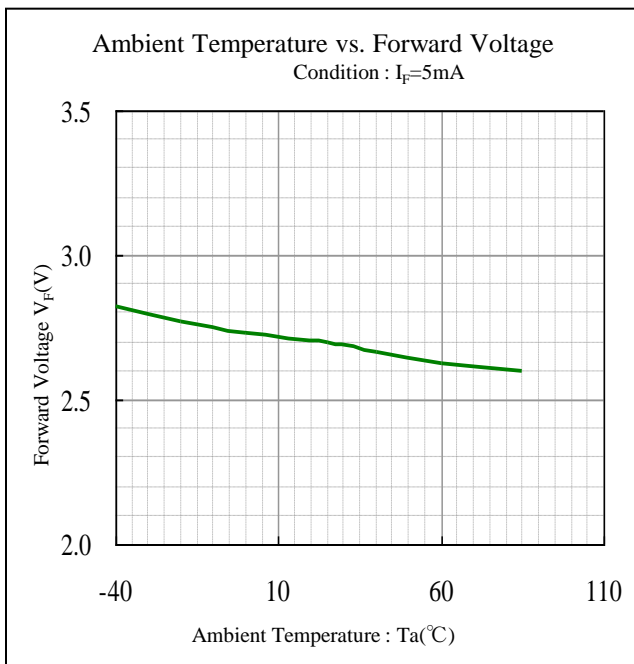
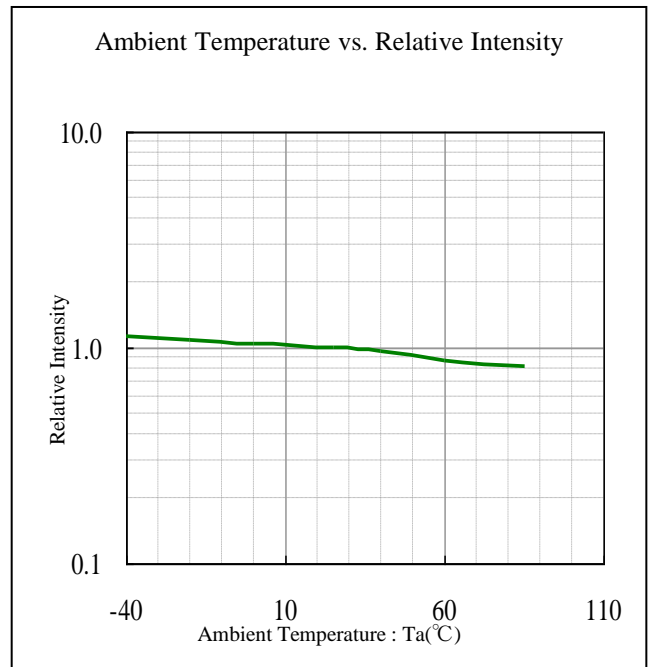
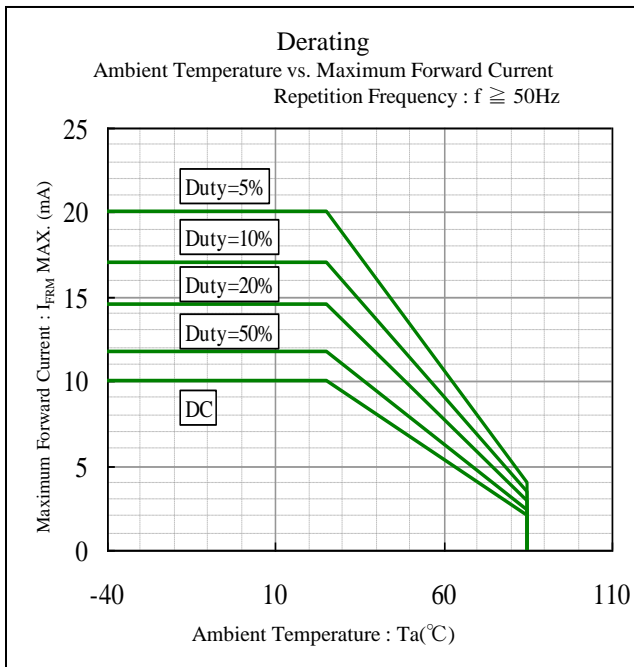

## Technical Data (GSW)

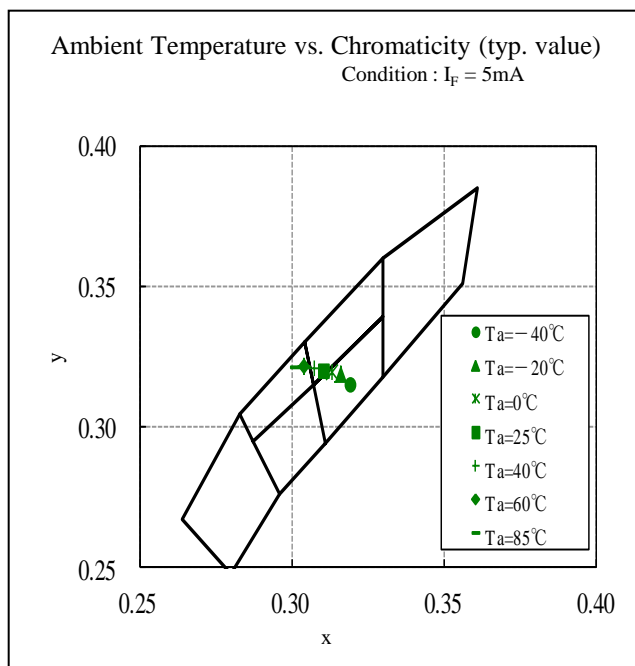
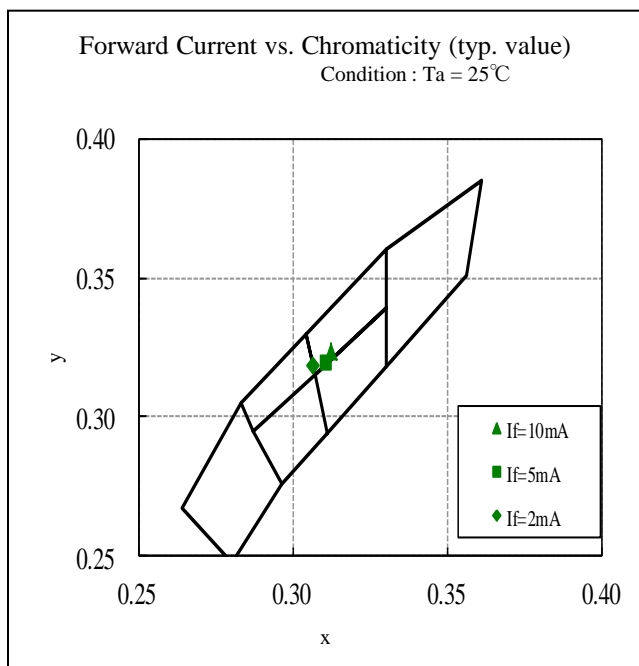
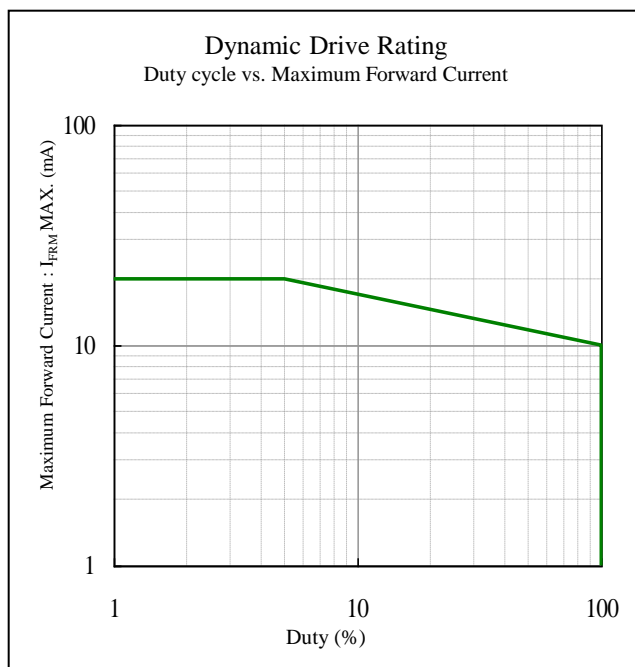
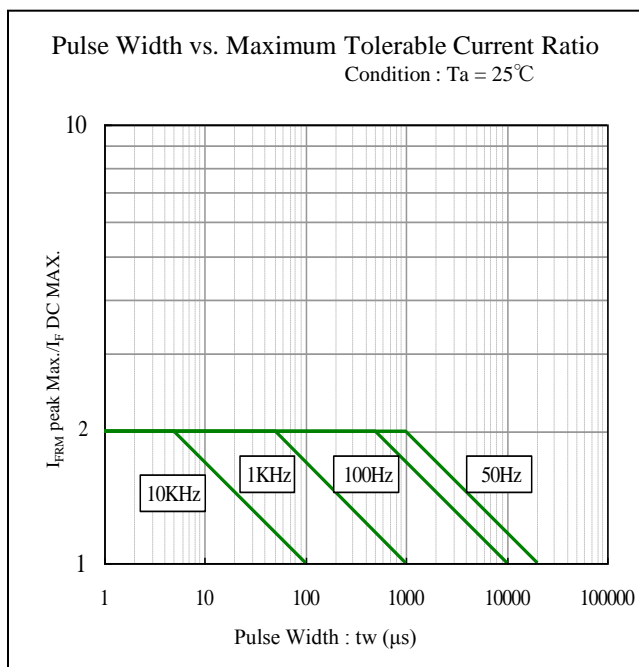



## Technical Data (GSB,GSG)

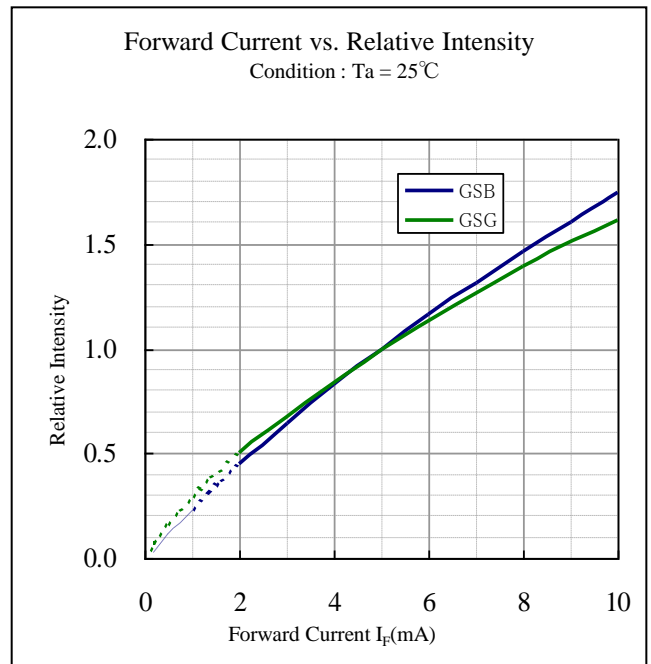
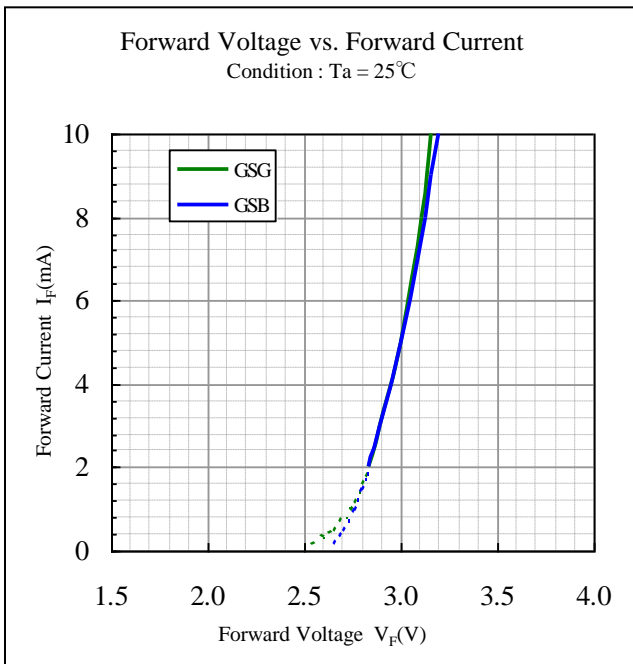
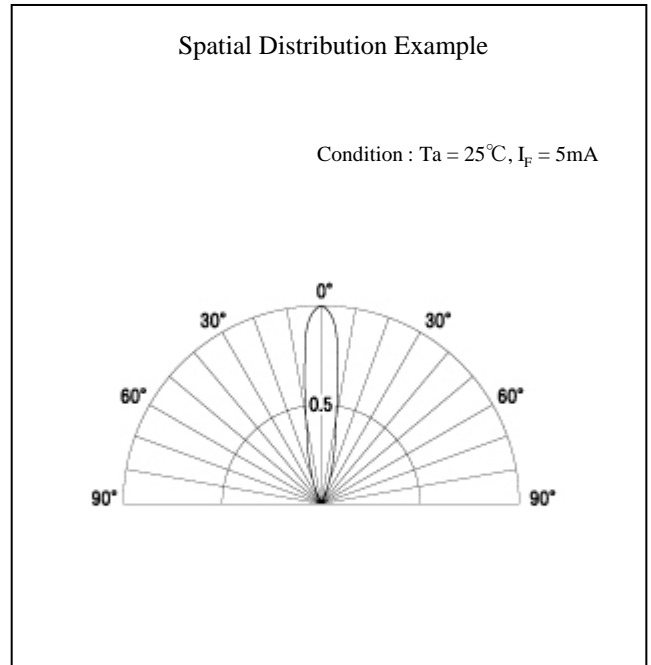
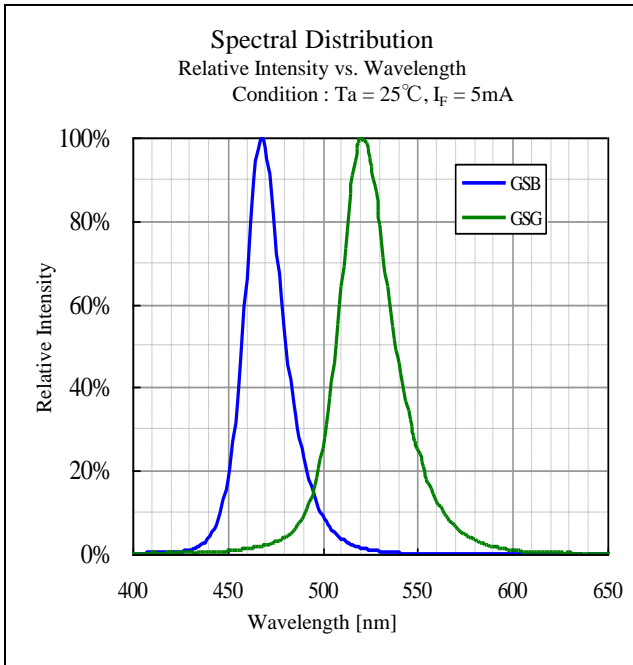

## Technical Data (GSB,GSG)

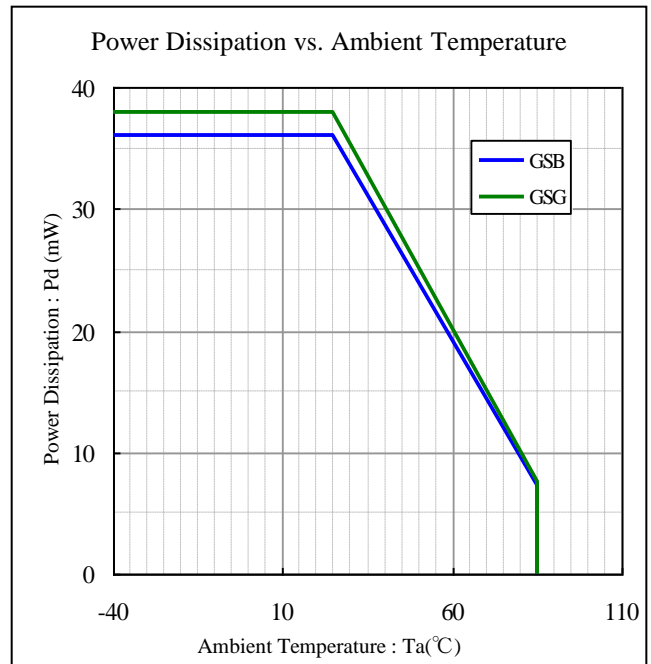
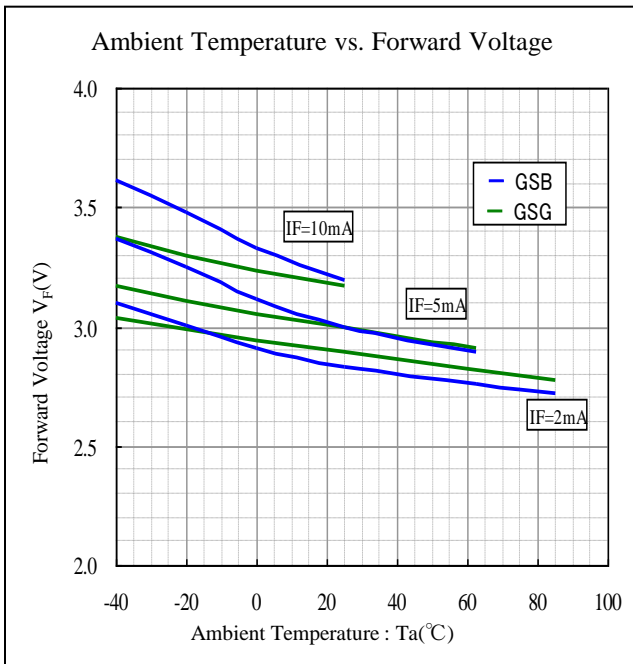
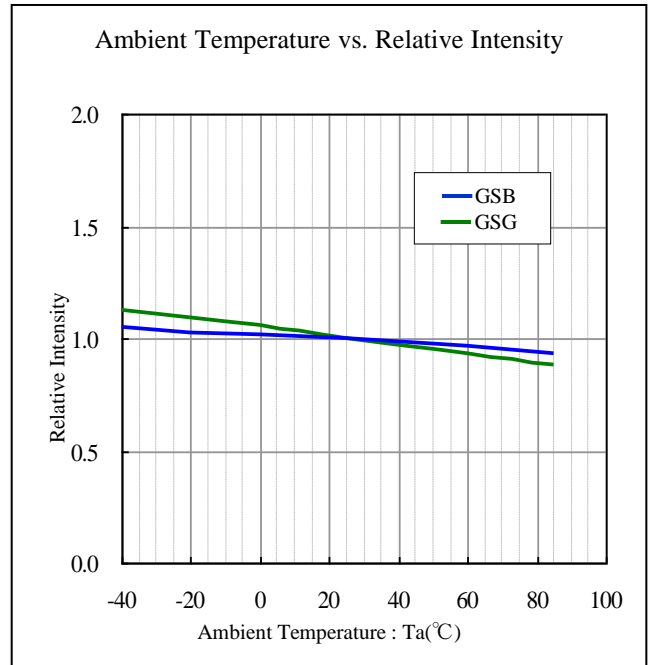
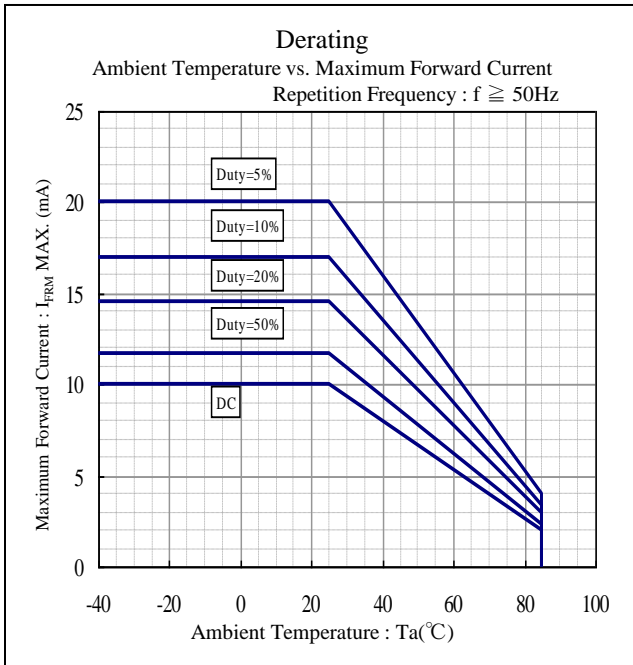

## Technical Data (GSB,GSG)

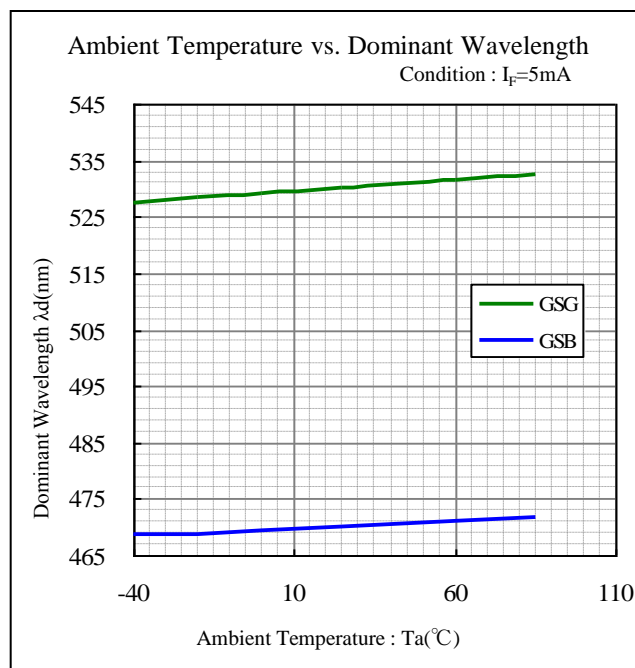
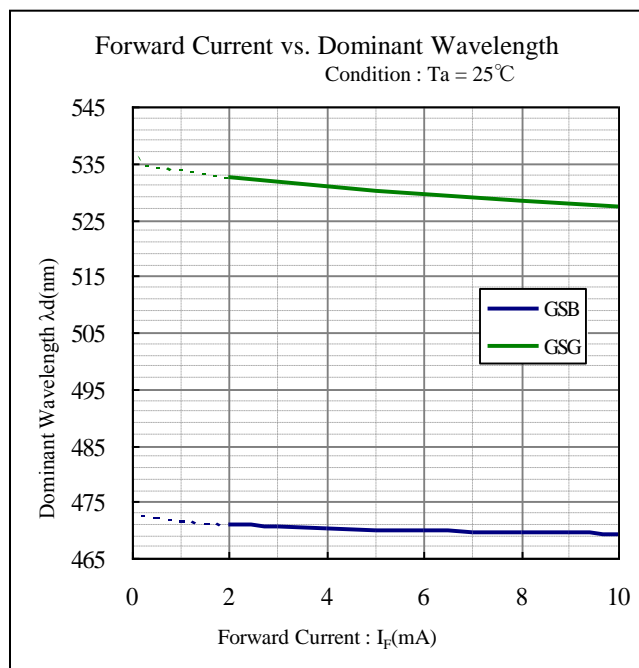
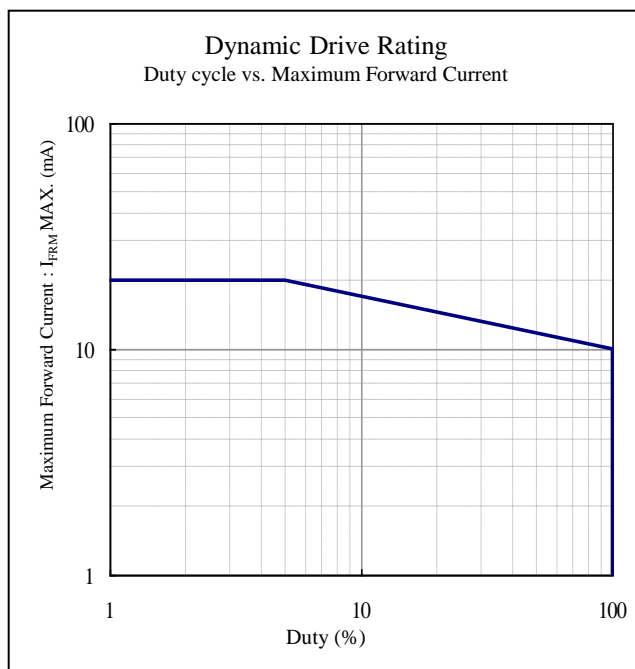
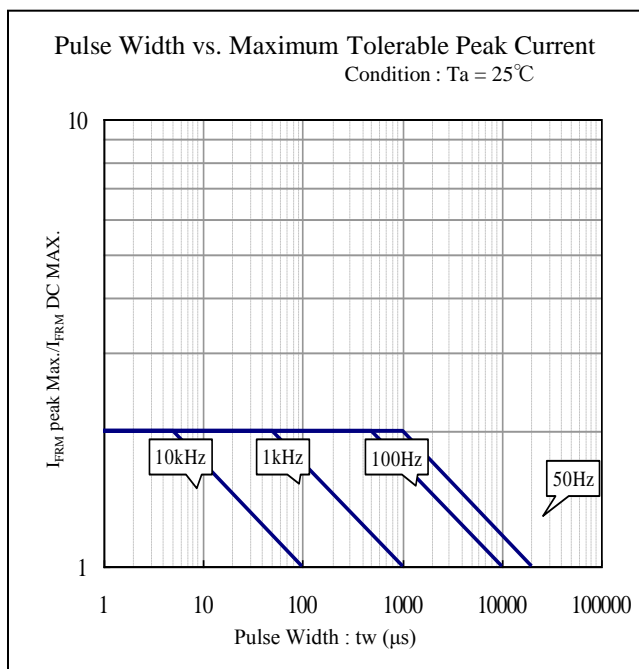

## Package Dimensions

(Unit: mm)

Mass : (0.16)g

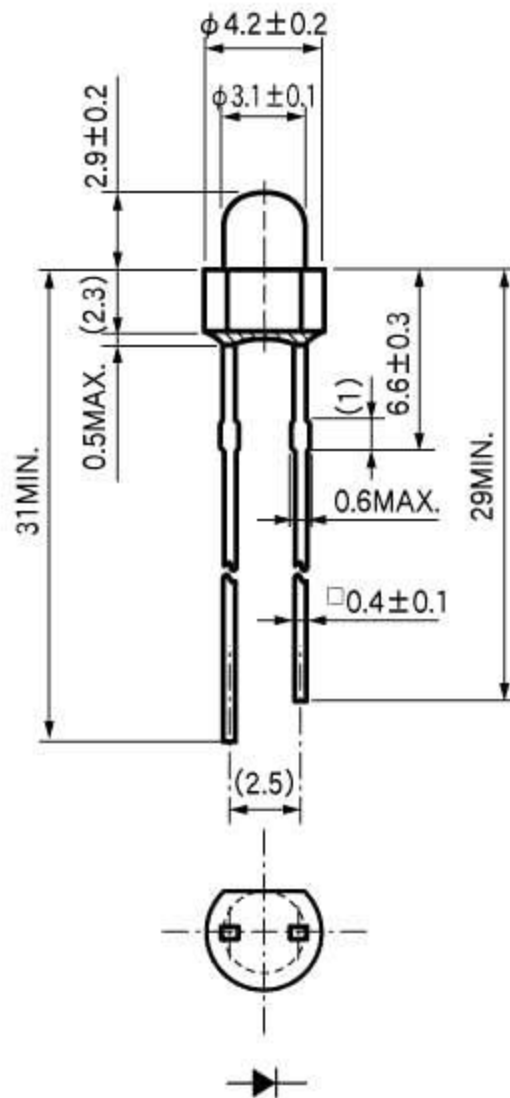

## TTW (Through The Wave) soldering Conditions

---

Pre-heating	100 °C	(MAX.)
Solder Bath Temp.	265°C	(MAX.)
Dipping Time	5 s	(MAX.)

- 1) The dip soldering process shall be 2 times maximum.
- 2) The product shall be cooled to room temp. before the second dipping process.

※The detail is described to LED and Photodetector handling precautions of home page:  
 "Mounting through-hole Type Devices" and "Soldering", and use it after the confirmation, please.

## Manual Soldering Conditions

---

Iron tip temp.	360°C	(MAX.)
Soldering time and frequency	3 s	(MAX.)
	2 times	(MAX.)

※The detail is described to LED and Photodetector handling precautions of home page:  
 "Mounting through-hole Type Devices" and "Soldering", and use it after the confirmation, please.

## Reliability Testing Result

Reliability Testing Result	Applicable Standard	Testing Conditions	Duration	Failure
Room Temp. Operating Life	EIAJ ED-4701/100(101)	Ta = 25°C, IF = Maximum Rated Current	1,000 h	0/25
Resistance to Soldering Heat	EIAJ ED-4701/300(302)	260±5°C, 1.6mm from package base	10s	0/25
Temperature Cycling	EIAJ ED-4701/100(105)	Minimum Rated Storage Temperature(30min) ~ Normal Temperature(15min) ~ Maximum Rated Storage Temperature(30min) ~ Normal Temperature(15min)	5 cycles	0/25
Wet High Temp. Storage Life	EIAJ ED-4701/100(103)	Ta = 60±2°C, RH = 90±5%	1,000 h	0/25
High Temp. Storage Life	EIAJ ED-4701/200(201)	Ta = Maximum Rated Storage Temperature	1,000 h	0/25
Low Temp. Storage Life	EIAJ ED-4701/200(202)	Ta = Minimum Rated Storage Temperature	1,000 h	0/25
Lead Tension	EIAJ ED-4701/400(401)	10N, 1time (□0.4 and Flat Package : 5N)	10s	0/10
Vibration, Variable Frequency	EIAJ ED-4701/400(403)	98.1m/s <sup>2</sup> (10G), 100 ~ 2KHz sweep for 20min., XYZ each direction	2 h	0/10

## Failure Criteria

Items	Symbols	Conditions	Failure criteria
Luminous Intensity	IV	IF Value of each product Luminous Intensity	Testing Min. Value < Spec. Min. Value x 0.5
Forward Voltage	VF	IF Value of each product Forward Voltage	Testing Max. Value ≥ Spec. Max. Value x 1.2
Reverse Current	IR	VR = Maximum Rated Reverse Voltage V	Testing Max. Value ≥ Spec. Max. Value x 2.5
Cosmetic Appearance	-	-	Occurrence of notable decoloration, deformation and cracking

## Special Notice to Customers Using the Products and Technical Information Shown in This Data Sheet

- 1) The technical information shown in the data sheets are limited to the typical characteristics and circuit examples of the referenced products. It does not constitute the warranting of industrial property nor the granting of any license.
- 2) For the purpose of product improvement, the specifications, characteristics and technical data described in the data sheets are subject to change without prior notice. Therefore it is recommended that the most updated specifications be used in your design.
- 3) When using the products described in the data sheets, please adhere to the maximum ratings for operating voltage, heat dissipation characteristics, and other precautions for use. We are not responsible for any damage which may occur if these specifications are exceeded.
- 4) The products that have been described to this catalog are manufactured so that they will be used for the electrical instrument of the benchmark (OA equipment, telecommunications equipment, AV machine, home appliance and measuring instrument).  
The application of aircrafts, space borne application, transportation equipment, medical equipment and nuclear power control equipment, etc. needs a high reliability and safety, and the breakdown and the wrong operation might influence the life or the human body. Please consult us beforehand if you plan to use our product for the usages of aircrafts, space borne application, transportation equipment, medical equipment and nuclear power control equipment, etc. except OA equipment, telecommunications equipment, AV machine, home appliance and measuring instrument.
- 5) In order to export the products or technologies described in this data sheet which are under the "Foreign Exchange and Foreign Trade Control Law," it is necessary to first obtain an export permit from the Japanese government.
- 6) No part of this data sheet may be reprinted or reproduced without prior written permission from Stanley Electric Co., Ltd.
- 7) The most updated edition of this data sheet can be obtained from the address below:  
<http://www.stanley-components.com/en>