

Dual high slew rate operational amplifier

BA4560 / BA4560F / BA4560N

The BA4560, BA4560F, and BA4560N are dual operational amplifiers which achieve approximately twice the high output current of the BA4558, as well as featuring a higher slew rate of $4V / \mu s$, a gain band width of 10MHz, and an improved frequency characteristic. The following packages are available: 8-pin DIP (BA4560), 8-pin SOP (BA4560F), and 8-pin SIP (BA4560N).

●Applications

- Active filters
- Audio amplifiers
- VCOs
- Other electronic circuits

●Features

- 1) Built-in output short-circuit protection circuit.
- 2) Internal phase correction.
- 3) No latch-up.
- 4) Wide range of common-mode modes and differential voltage.
- 5) High gain and low noise.

●Block diagram

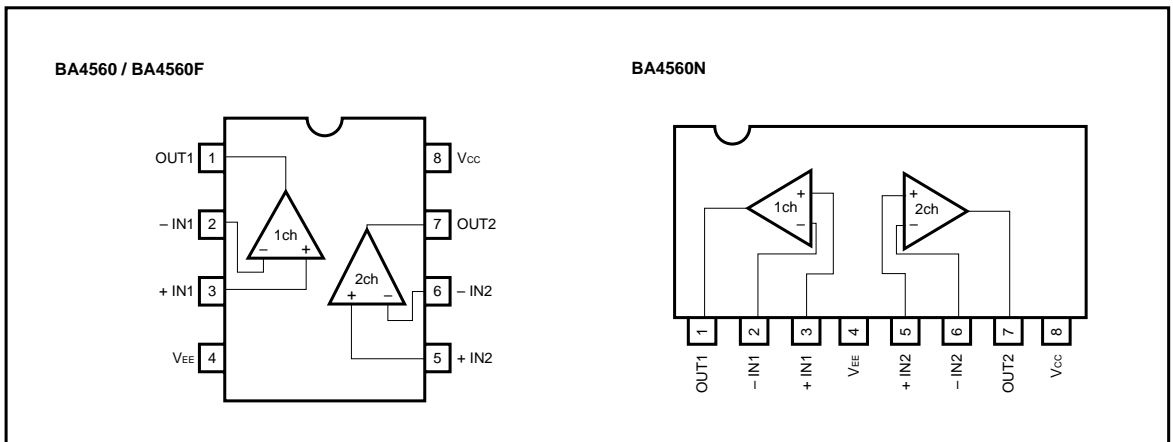

●Internal circuit configuration

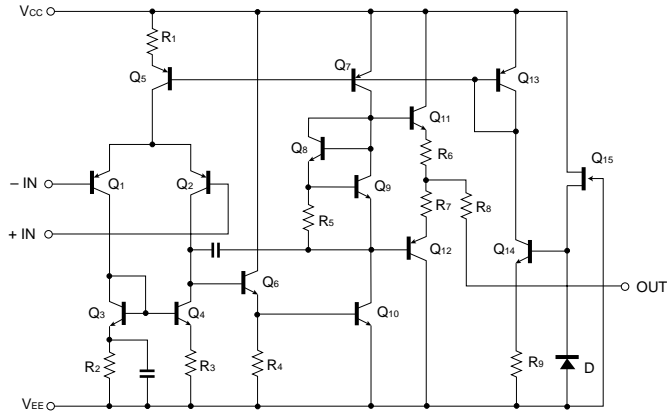

●Absolute maximum ratings (Ta = 25°C)

| Parameter | Symbol | Limits | | | Unit |
|----------------------------|------------------|-------------------------------------|---------|---------|------|
| | | BA4560 | BA4560F | BA4560N | |
| Power supply voltage | V _{CC} | ± 18 | ± 18 | ± 18 | V |
| Power dissipation | P _d | 800* | 550* | 900* | mW |
| Differential input voltage | V _{ID} | ± V _{CC} | | | V |
| Common-mode input voltage | V _I | - V _{CC} ~ V _{CC} | | | V |
| Operating temperature | T _{opr} | - 40 ~ + 85 | | | °C |
| Storage temperature | T _{stg} | - 55 ~ + 125 | | | °C |

* Refer to the P_d characteristics diagram. The values for the BA4560F are those when it is mounted on a glass epoxy PCB (50mm × 50mm × 1.6mm).

●Electrical characteristics (unless otherwise noted, Ta = 25°C, V_{CC} = +15 V, V_{EE} = -15 V)

| Parameter | Symbol | Min. | Typ. | Max. | Unit | Conditions |
|--------------------------------------|------------------|------|------|------|--------|----------------------------------------------|
| Input offset voltage | V _{IO} | — | 0.5 | 6.0 | mV | R _S ≤ 10kΩ |
| Input offset current | I _{IO} | — | 5 | 200 | nA | |
| Input bias current | I _B | — | 50 | 500 | nA | |
| High-amplitude voltage gain | A _v | 86 | 100 | — | dB | R _L ≥ 2kΩ, V _o = ± 10V |
| Common-mode input voltage | V _{ICM} | ± 12 | ± 14 | — | V | |
| Maximum output voltage 1 | V _{OM1} | ± 12 | ± 14 | — | V | R _L ≥ 10kΩ |
| Maximum output voltage 2 | V _{OM2} | ± 10 | ± 13 | — | V | R _L ≥ 2kΩ |
| Common-mode rejection ratio | CMRR | 70 | 90 | — | dB | R _S ≤ 10kΩ |
| Power supply voltage rejection ratio | PSRR | — | 30 | 150 | μV / V | R _S ≤ 10kΩ |
| Slew rate | S. R. | — | 4.0 | — | V / μs | A _v = 1, R _L = 2kΩ |
| Input conversion noise voltage | V _n | — | — | 2.2 | μV | |
| Gain band width product | GBW | — | 10 | — | MHz | f = 10kHz |

●Electrical characteristic curves

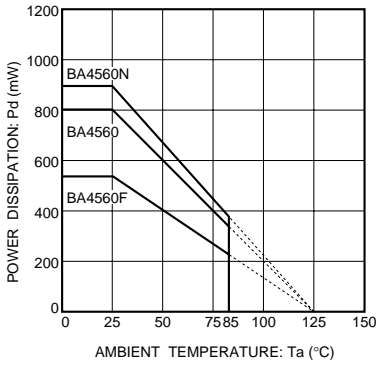

Fig.1 Power dissipation vs. ambient temperature

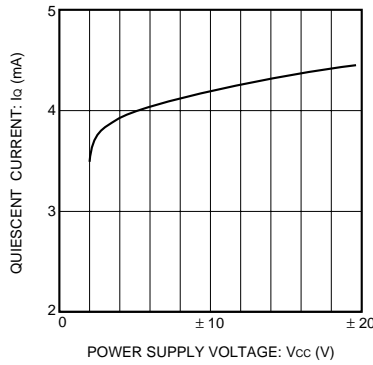

Fig.2 Quiescent current vs. power supply voltage

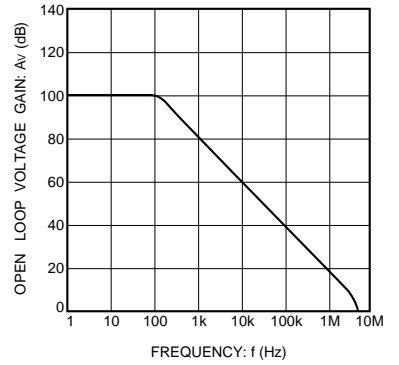

Fig.3 Open loop voltage gain vs. frequency

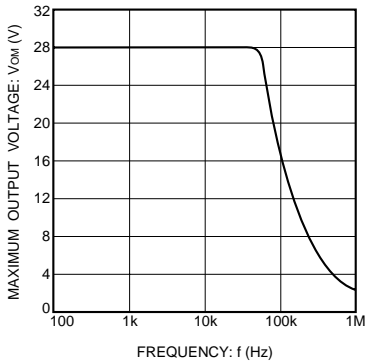

Fig.4 Maximum output voltage vs. frequency

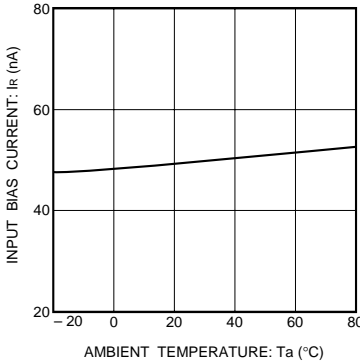

Fig.5 Input bias current vs. ambient temperature

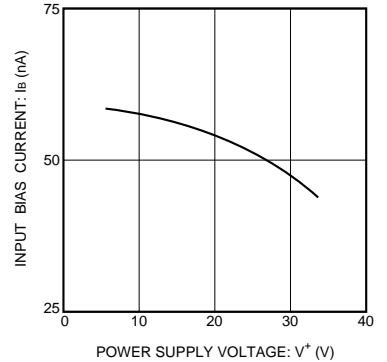

Fig.6 Input bias current vs. power supply voltage

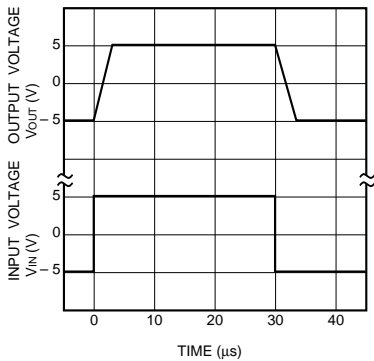

Fig.7 Output response characteristics

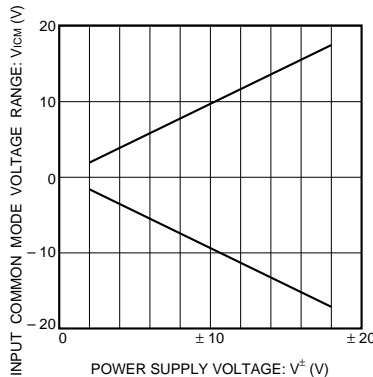

Fig.8 Common mode input voltage vs. power supply voltage

●Operation notes

(1) Handling unused circuits

If there are any circuits which are not being used, we recommend making connections as shown in Figure 9, with the non-inverted input pin connected to the potential within the in-phase input voltage range (V_{ICM}).

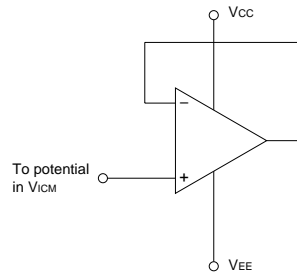

Fig.9 Unused circuit connections

●Exteral dimensions (Units: mm)

