

---

*Fully Integrated, Hall Effect-Based Linear Current Sensor IC  
with Voltage Isolation and a Low-Resistance Current Conductor*

---

## **Discontinued Product**

These parts are no longer in production. The device should not be purchased for new design applications. Samples are no longer available.

Date of status change: October 30, 2007

### **Recommended Substitutions:**

*For existing customer transition, and for new customers or new applications, refer to the [ACS712](#).*

---

NOTE: For detailed information on purchasing options, contact your local Allegro field applications engineer or sales representative.

---

*Allegro MicroSystems, Inc. reserves the right to make, from time to time, revisions to the anticipated product life cycle plan for a product to accommodate changes in production capabilities, alternative product availabilities, or market demand. The information included herein is believed to be accurate and reliable. However, Allegro MicroSystems, Inc. assumes no responsibility for its use; nor for any infringements of patents or other rights of third parties which may result from its use.*

---

# ACS704ELC-015

## Fully Integrated, Hall Effect-Based Linear Current Sensor IC with Voltage Isolation and a Low-Resistance Current Conductor

Package LC

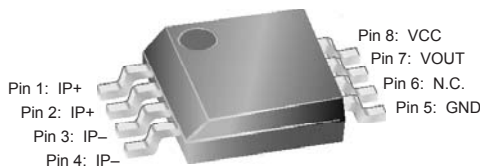

Pins 6 and 7 are internally connected in shipping product. For compatibility with future devices, leave pin 6 floating.

Nominal Operating Temperature,  $T_A$   
Range E ..... **-40 to 85°C**  
Overcurrent Transient Tolerance\*,  $I_P$  ..... **60 A**  
\*100 total pulses, 250 ms duration each, applied at a rate of 1 pulse every 100 seconds.

### ABSOLUTE MAXIMUM RATINGS

Supply Voltage,  $V_{CC}$  ..... **16 V**  
Reverse Supply Voltage,  $V_{RCC}$  ..... **-16 V**  
Output Voltage,  $V_{OUT}$  ..... **16 V**  
Reverse Output Voltage,  $V_{ROUT}$  ..... **-0.1 V**  
Output Current Source,  $I_{OUT(SOURCE)}$  ..... **3 mA**  
Output Current Sink,  $I_{OUT(SINK)}$  ..... **10 mA**  
Operating Temperature,  
Maximum Junction,  $T_{J(max)}$  ..... **165°C**  
Storage Temperature,  $T_S$  ..... **-65 to 170°C**

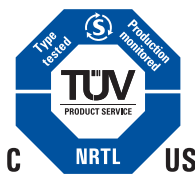

TÜV America  
Certificate Number:  
U8V 04 12 54214 005

The Allegro ACS704 family of current sensor ICs provides economical and precise solutions for current sensing in industrial, automotive, commercial, and communications systems. The device package allows for easy implementation by the customer. Typical applications include motor control, load detection and management, switched-mode power supplies, and overcurrent fault protection.

The device consists of a precision, low-offset linear Hall circuit with a copper conduction path located near the surface of the die. Applied current flowing through this copper conduction path generates a magnetic field which the integrated Hall IC converts into a proportional voltage. Device accuracy is optimized through the close proximity of the magnetic signal to the Hall transducer. A precise, proportional voltage is provided by the low-offset, chopper-stabilized BiCMOS Hall IC, which is programmed for accuracy at the factory.

The output of the device has a positive slope ( $>V_{CC}/2$ ) when an increasing current flows through the primary copper conduction path (from pins 1 and 2, to pins 3 and 4), which is the path used for current sampling. The internal resistance of this conductive path is typically 1.5 mΩ, providing low power loss. The thickness of the copper conductor allows survival of the device at up to 3× overcurrent conditions. The terminals of the conductive path are electrically isolated from the signal leads (pins 5 through 8). This allows the ACS704 to be used in applications requiring electrical isolation without the use of opto-isolators or other costly isolation techniques.

The ACS704 is provided in a small, surface mount SOIC8 package. The leadframe is plated with 100% matte tin, which is compatible with standard lead (Pb) free printed circuit board assembly processes. Internally, the flip-chip uses high-temperature Pb-based solder balls, currently exempt from RoHS. The device is fully calibrated prior to shipment from the factory.

### Features and Benefits

- Small footprint, low-profile SOIC8 package
- 1.5 mΩ internal conductor resistance
- 800  $V_{RMS}$  minimum isolation voltage between pins 1-4 and 5-8
- 4.5 to 5.5 V, single supply operation
- 50 kHz bandwidth
- 100 mV/A output sensitivity and 20 A dynamic range
- Output voltage proportional to ac and dc currents
- Factory-trimmed for accuracy
- Extremely stable output offset voltage
- Near-zero magnetic hysteresis
- Ratiometric output from supply voltage

Use the following complete part number when ordering:

Part Number	Package
ACS704ELC-015	SOIC8 surface mount

# ACS704ELC-015

## Functional Block Diagram

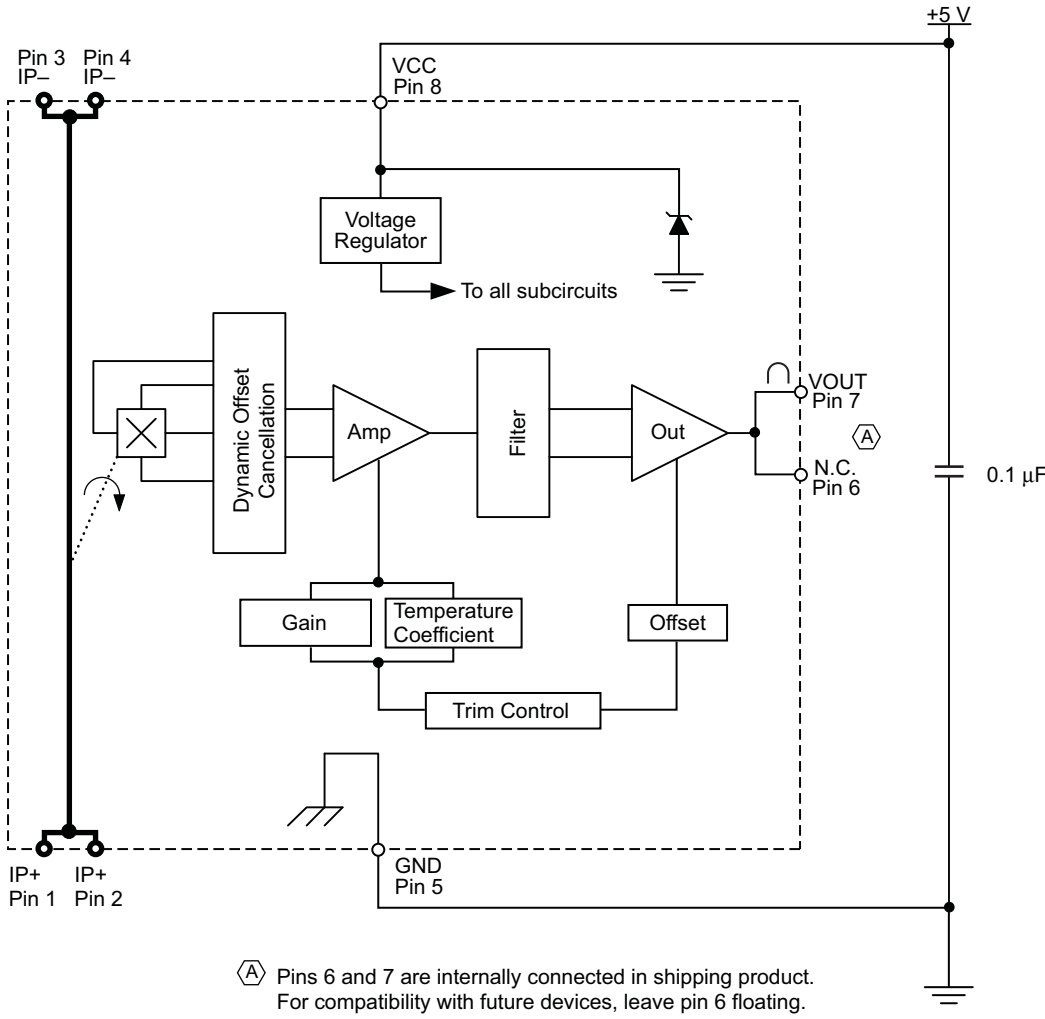

# ACS704ELC-015

## ELECTRICAL CHARACTERISTICS, over operating ambient temperature range unless otherwise stated

Characteristic	Symbol	Test Conditions	Min.	Typ.	Max.	Units
Primary Sensed Current <sup>1</sup>	$I_P$		-15	-	15	A
Supply Voltage	$V_{CC}$		4.5	5.0	5.5	V
Supply Current	$I_{CC}$	$V_{CC} = 5.0$ V, output open	5	8	10	mA
Output Resistance	$R_{OUT}$	$I_{OUT} = 1.2$ mA	-	1	2	$\Omega$
Output Capacitance Load	$C_{LOAD}$	VOUT to GND	-	-	10	nF
Output Resistive Load	$R_{LOAD}$	VOUT to GND	4.7	-	-	k $\Omega$
Primary Conductor Resistance	$R_{PRIMARY}$	$T_A = 25^\circ\text{C}$	-	1.5	-	m $\Omega$
Isolation Voltage	$V_{ISO}$	Pins 1-4 and 5-8; 60 Hz, 1 minute	800	1200	-	V
<b>PERFORMANCE CHARACTERISTICS, <math>T_A = -40^\circ\text{C}</math> to <math>85^\circ\text{C}</math>, <math>V_{CC} = 5</math> V unless otherwise specified</b>						
Propagation Time	$t_{PROP}$	$I_P = \pm 15$ A, $T_A = 25^\circ\text{C}$	-	4	-	$\mu\text{s}$
Response Time	$t_{RESPONSE}$	$I_P = \pm 15$ A, $T_A = 25^\circ\text{C}$	-	8	-	$\mu\text{s}$
Rise Time	$t_r$	$I_P = \pm 15$ A, $T_A = 25^\circ\text{C}$	-	9	-	$\mu\text{s}$
Frequency Bandwidth	f	-3 dB, $T_A = 25^\circ\text{C}$ ; $I_P$ is 10 A peak-to-peak; no external filter	-	50	-	kHz
Sensitivity	Sens	Over full range of $I_P$ , $I_P$ applied for 5 ms; $T_A = 25^\circ\text{C}$	-	100	-	mV/A
		Over full range of $I_P$ , $I_P$ applied for 5 ms; $T_A = -40$ to $85^\circ\text{C}$	94	-	106	mV/A
Noise	$V_{NOISE}$	Peak-to-peak, $T_A = 25^\circ\text{C}$ , no external filter	-	70	-	mV
		Root Mean Square, $T_A = 25^\circ\text{C}$ , no external filter	-	12.5	-	mV
Linearity	$E_{LIN}$	Over full range of $I_P$ , $I_P$ applied for 5 ms; $T_A = -40$ to $85^\circ\text{C}$	-	$\pm 1$	$\pm 3.5$	%
Symmetry	$E_{SYM}$	Over full range of $I_P$ , $I_P$ applied for 5 ms; $T_A = -40$ to $85^\circ\text{C}$	98	100	102	%
Zero Current Output Voltage	$V_{OUT(Q)}$	$I_P = 0$ A, $T_A = 25^\circ\text{C}$	-	$V_{CC} / 2$	-	V
Electrical Offset Voltage	$V_{OE}$	$I_P = 0$ A, $T_A = 25^\circ\text{C}$	-15	-	15	mV
		$I_P = 0$ A, $T_A = -40$ to $85^\circ\text{C}$	-50	-	50	mV
Magnetic Offset Error	$I_{ERROM}$	$I_P = 0$ A, after excursion of 15 A; $T_A = -40$ to $85^\circ\text{C}$	-	$\pm 0.01$	$\pm 0.05$	A
Total Output Error <sup>2</sup>	$E_{TOT}$	$I_P = \pm 15$ A, $I_P$ applied for 5 ms; $T_A = 25^\circ\text{C}$	-	$\pm 1.5$	-	%
		$I_P = \pm 10$ A, $I_P$ applied for 5 ms; $T_A = -40$ to $85^\circ\text{C}$	-	-	$\pm 6.0$	%
		$I_P = \pm 15$ A, $I_P$ applied for 5 ms; $T_A = -40$ to $85^\circ\text{C}$	-	-	$\pm 8.4$	%

<sup>1</sup>Device may be operated at higher primary current,  $I_P$ , and Ambient Temperature,  $T_A$ , levels, provided that the Maximum Junction Temperature,  $T_{J(max)}$  is not exceeded.

<sup>2</sup>Percentage of  $I_P$ , with  $I_P = 15$  A; Output filtered. Up to a 2.0% shift in  $E_{TOT}$  may be observed at end-of-life for this device.

# ACS704ELC-015

Typical Performance Characteristics  
Supply Current versus Ambient Temperature  
 $V_{CC} = 5\text{ V}$

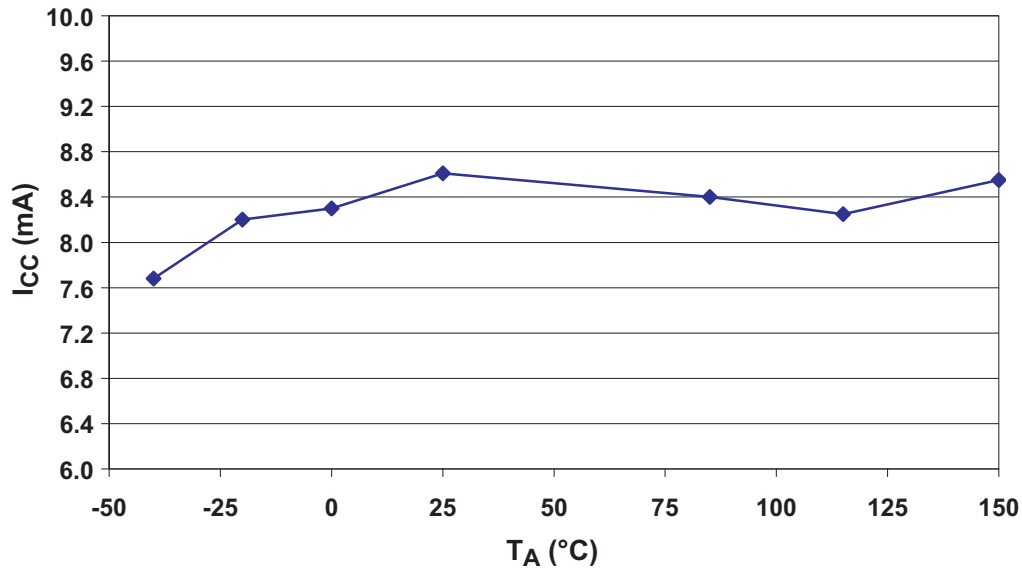

Supply Current versus Applied  $V_{CC}$

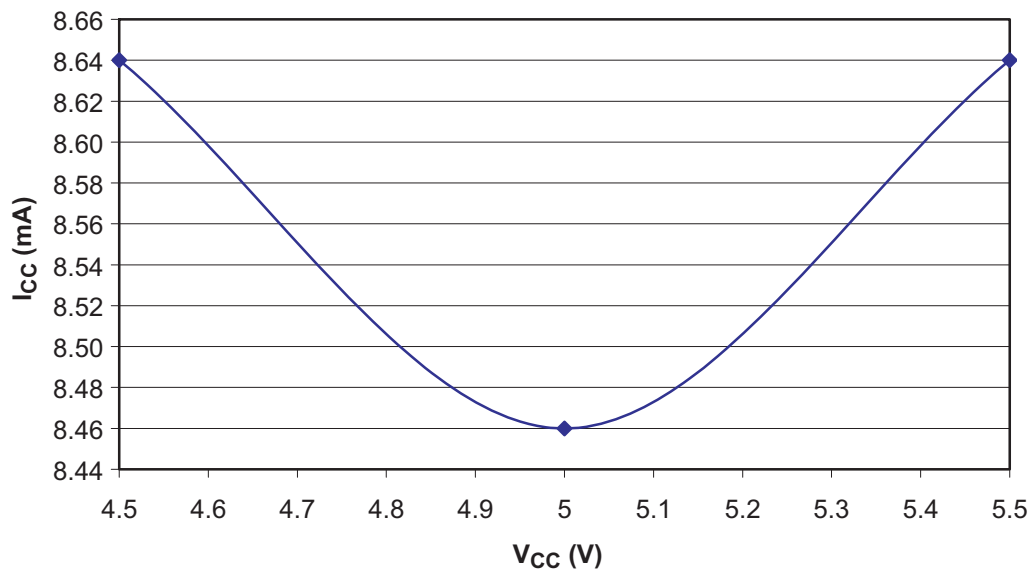

# ACS704ELC-015

Output Voltage versus Primary Current  
 $V_{CC} = 5\text{ V}$

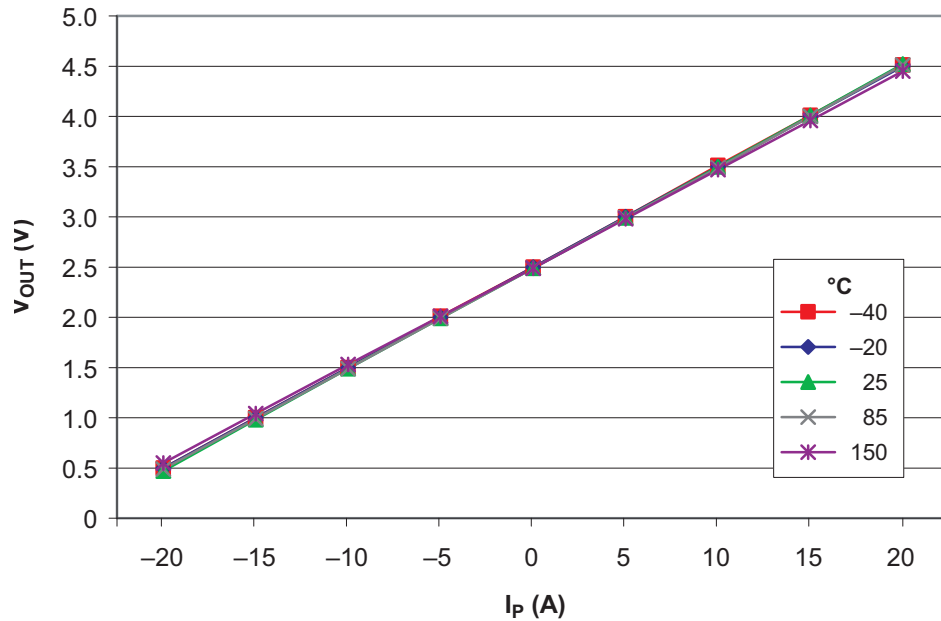

Sensitivity versus Primary Current  
 $V_{CC} = 5\text{ V}$

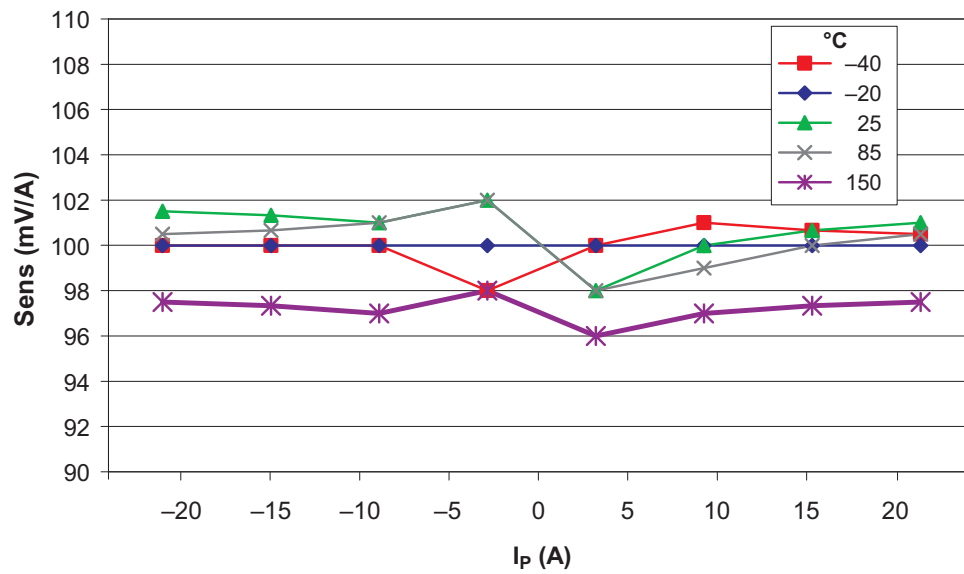

# ACS704ELC-015

## Zero Current Output Voltage vs. Ambient Temperature

$I_P = 0\text{ A}$

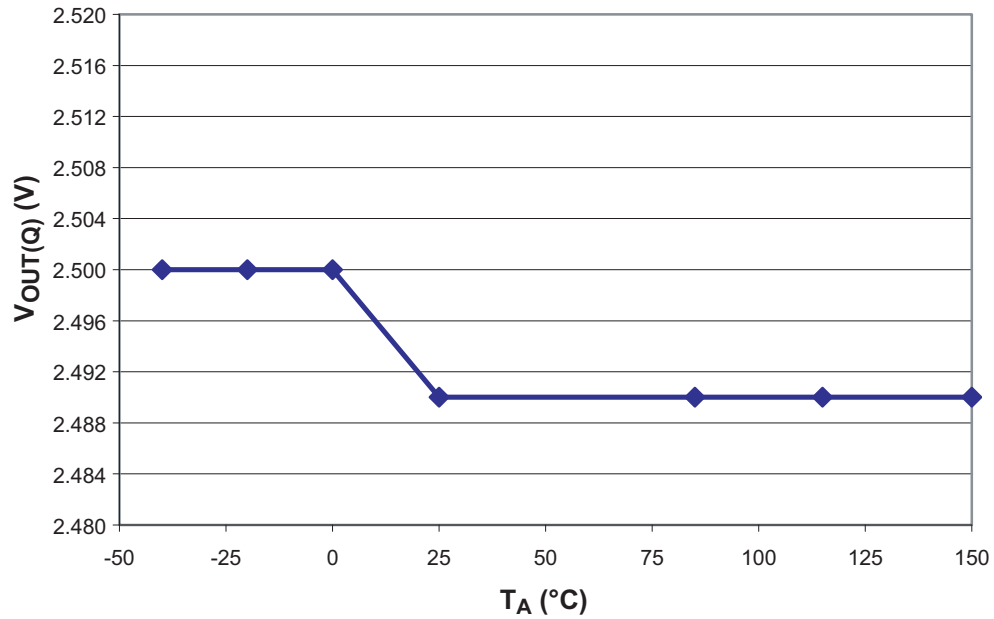

## Zero Current Output Current versus Ambient Temperature

(Data in above chart converted to amperes)

$I_P = 0\text{ A}$

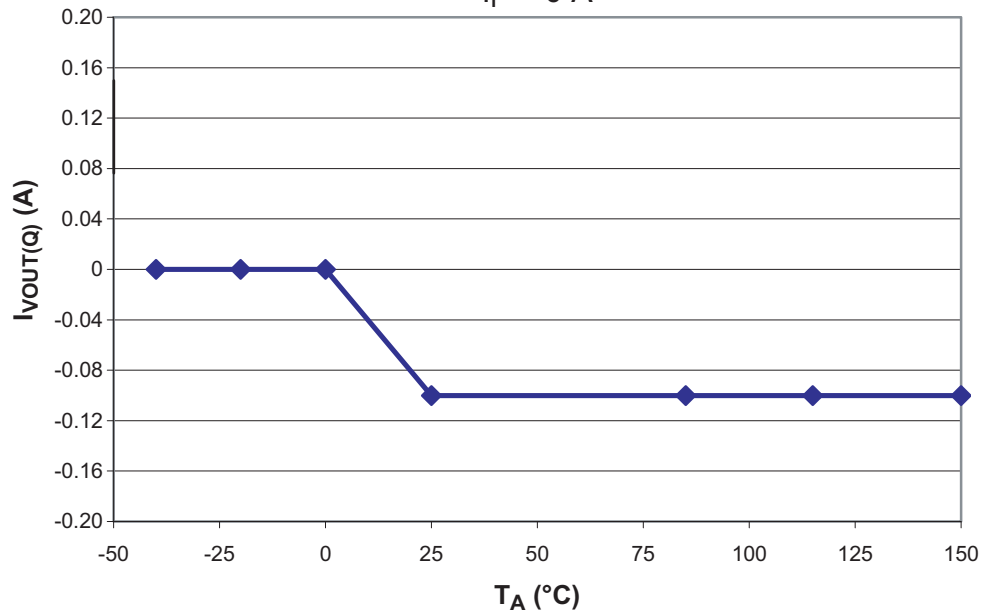

# ACS704ELC-015

## Magnetic Offset versus Ambient Temperature

$V_{CC} = 5\text{ V}$ ;  $I_P = 0\text{ A}$ , after excursion to 20 A

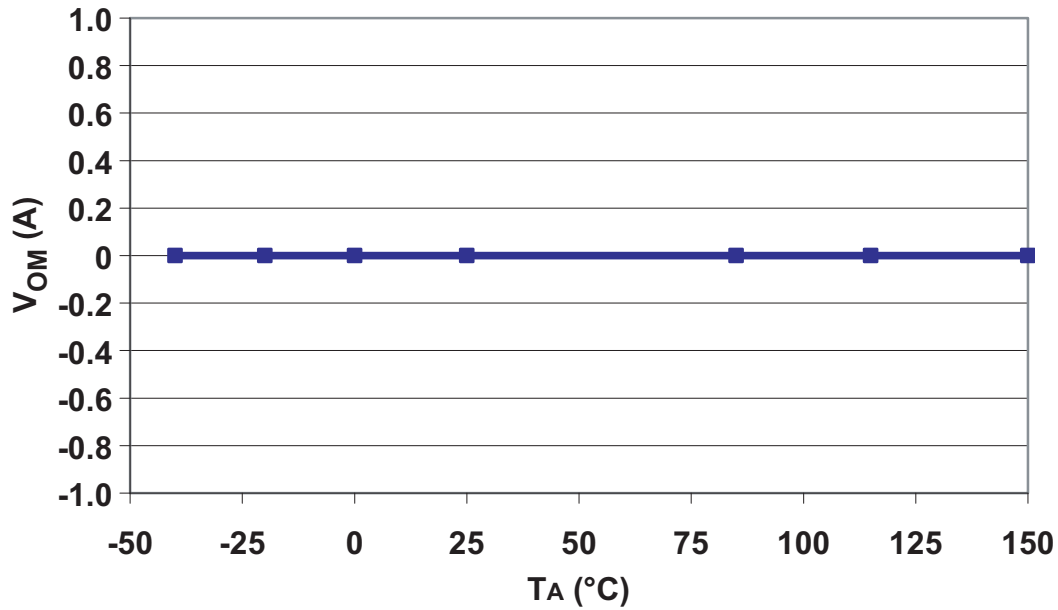

## Nonlinearity versus Ambient Temperature

$V_{CC} = 5\text{ V}$   $I_P = 15\text{ A}$

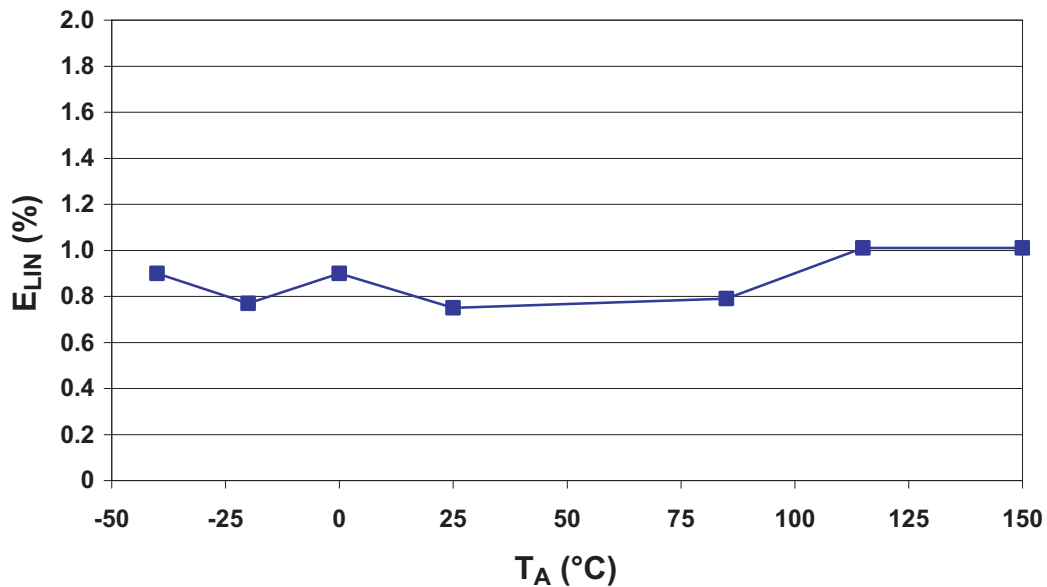



# ACS704ELC-015

## Attenuation of ACS704 Output versus AC Sinusoidal Current Frequency

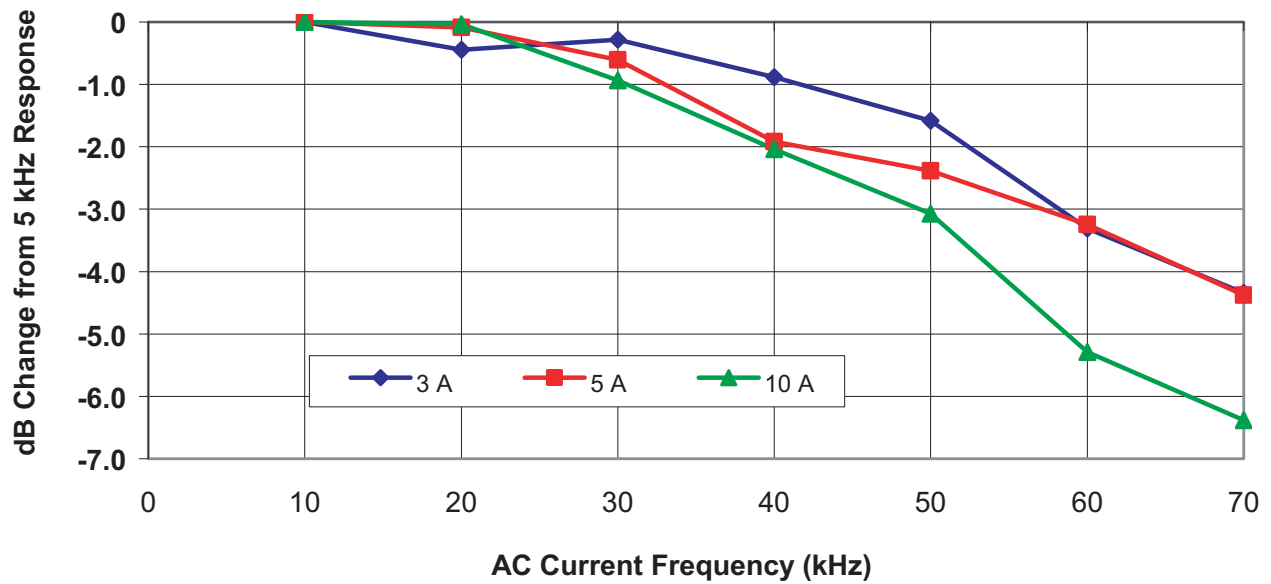

# ACS704ELC-015

Step Response of ACS704ELC-015 at  $T_A=25^\circ\text{C}$

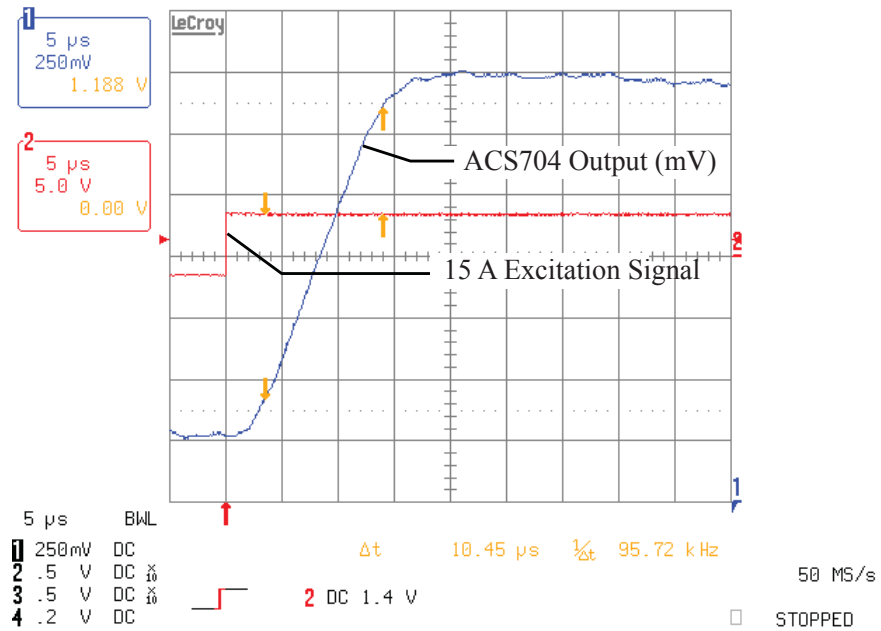

Typical Peak-to-Peak Noise of ACS704ELC-015 at  $T_A=25^\circ\text{C}$

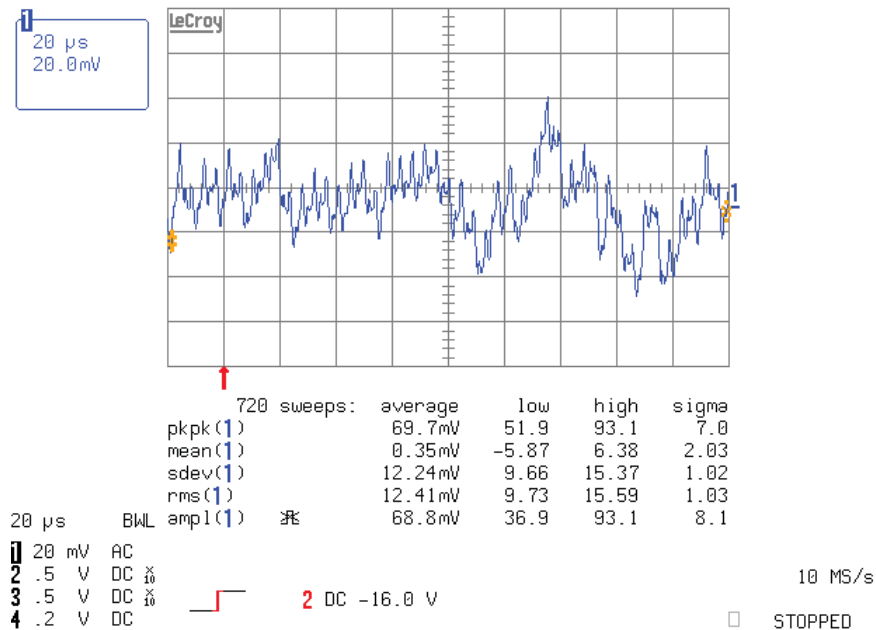

# ACS704ELC-015

## ACS704ELC-015 Noise Filtering and Frequency Response Performance

Break Frequency of Filter on Output (kHz)	Nominal Programmed Sensitivity (mV/A)	Peak-to-Peak Noise (mV)	Resolution with Filtering (A)	Measured Rise Time for 5 A Step, filtered ( $\mu$ s)	Bandwidth as Derived from Step Response (kHz)
Unfiltered	100	75	$\approx 0.75$	9	40
50		46	$\approx 0.46$	10.5	33.3
40		43	$\approx 0.43$	12	30
10		25	$\approx 0.25$	35	10
7.0		17	$\approx 0.17$	70	5
3.3		12	$\approx 0.12$	101	3.3

### Typical Application Drawing

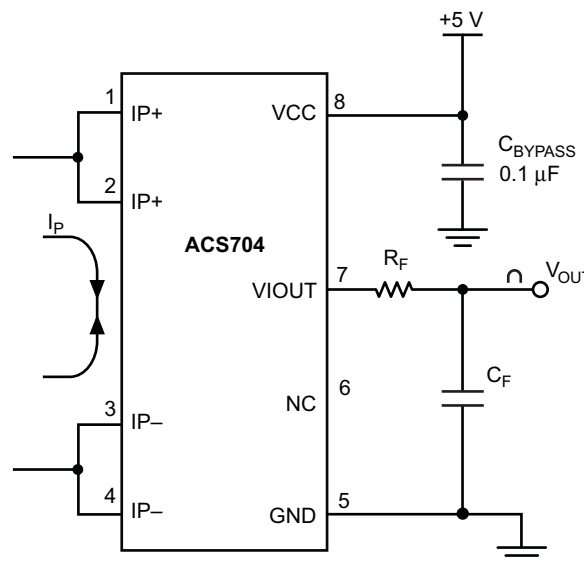

The ACS704 outputs an analog signal,  $V_{Sig}$ , that varies linearly with the bidirectional primary sampled current,  $I_p$ , within the range specified.  $R_F$  and  $C_F$ , are recommended for noise management, with values that depend on the application.

# ACS704ELC-015

## Definitions of Accuracy Characteristics

**Sensitivity (Sens).** The change in device output in response to a 1A change through the primary conductor. The sensitivity is the product of the magnetic circuit sensitivity (G/A) and the linear IC amplifier gain (mV/G). The linear IC amplifier gain is programmed at the factory to optimize the sensitivity (mV/A) for the full-scale current of the device.

**Noise ( $V_{\text{NOISE}}$ ).** The product of the linear IC amplifier gain (mV/G) and the noise floor for the Allegro Hall effect linear IC ( $\approx 1$  G). The noise floor is derived from the thermal and shot noise observed in Hall elements. Dividing the noise (mV) by the sensitivity (mV/A) provides the smallest current that the device is able to resolve.

**Linearity ( $E_{\text{LIN}}$ ).** The degree to which the voltage output from the device varies in direct proportion to the primary current through its full-scale amplitude. Nonlinearity in the output can be attributed to the saturation of the flux concentrator approaching the full-scale current. The following equation is used to derive the linearity:

$$100 \left\{ 1 - \left[ \frac{(V_{\text{out\_full-scale amperes}} - V_{\text{OUT(Q)}})}{2(V_{\text{out\_half-scale amperes}} - V_{\text{OUT(Q)}})} \right] \right\}$$

where  $V_{\text{out\_full-scale amperes}}$  = the output voltage (V) when the sampled current approximates full-scale  $\pm I_p$ .

**Symmetry ( $E_{\text{SYM}}$ ).** The degree to which the absolute voltage output from the device varies in proportion to either a positive or negative full-scale primary current. The following formula is used to derive symmetry:

$$100 \left( \frac{V_{\text{out\_+full-scale amperes}} - V_{\text{OUT(Q)}}}{V_{\text{OUT(Q)}} - V_{\text{out\_full-scale amperes}}} \right)$$

**Quiescent output voltage ( $V_{\text{OUT(Q)}}$ ).** The output of the device when the primary current is zero. For a unipolar supply voltage, it nominally remains at  $V_{\text{CC}}/2$ . Thus,  $V_{\text{CC}} = 5$  V translates into  $V_{\text{OUT(Q)}} = 2.5$  V. Variation in  $V_{\text{OUT(Q)}}$  can be attributed to the resolution of the Allegro linear IC quiescent voltage trim and thermal drift.

**Electrical offset voltage ( $V_{\text{OE}}$ ).** The deviation of the device output from its ideal quiescent value of  $V_{\text{CC}}/2$  due to nonmagnetic causes. To convert this voltage to amperes, divide by the device sensitivity, Sens.

**Accuracy ( $E_{\text{TOT}}$ ).** The accuracy represents the maximum deviation of the actual output from its ideal value. This is also known as the total output error. The accuracy is illustrated graphically in the Output Voltage versus Current chart on the following page.

Accuracy is divided into four areas:

- **0 A at 25°C.** Accuracy at zero current flow at 25°C, without the effects of temperature.
- **0 A over  $\Delta$  temperature.** Accuracy at zero current flow including temperature effects.
- **Full-scale current at 25°C.** Accuracy at the full-scale current at 25°C, without the effects of temperature.
- **Full-scale current over  $\Delta$  temperature.** Accuracy at full-scale current flow including temperature effects.

**Ratiometry.** The ratiometric feature means that its 0 A output,  $V_{\text{OUT(Q)}}$ , (nominally equal to  $V_{\text{CC}}/2$ ) and sensitivity, Sens, are proportional to its supply voltage,  $V_{\text{CC}}$ . The following formula is used to derive the ratiometric change in 0 A output voltage,  $\Delta V_{\text{OUT(Q)RAT}}$

$$100 \left( \frac{V_{\text{OUT(Q)VCC}} / V_{\text{OUT(Q)5V}}}{V_{\text{CC}} / 5 \text{ V}} \right)$$

(%): The ratiometric change in sensitivity,  $\Delta \text{Sens}_{\text{RAT}}$  (%), is defined as:

$$100 \left( \frac{\text{Sens}_{\text{VCC}} / \text{Sens}_{\text{5V}}}{V_{\text{CC}} / 5 \text{ V}} \right)$$

# ACS704ELC-015

Output voltage vs. current, illustrating device accuracy at 0 A and at full-scale current

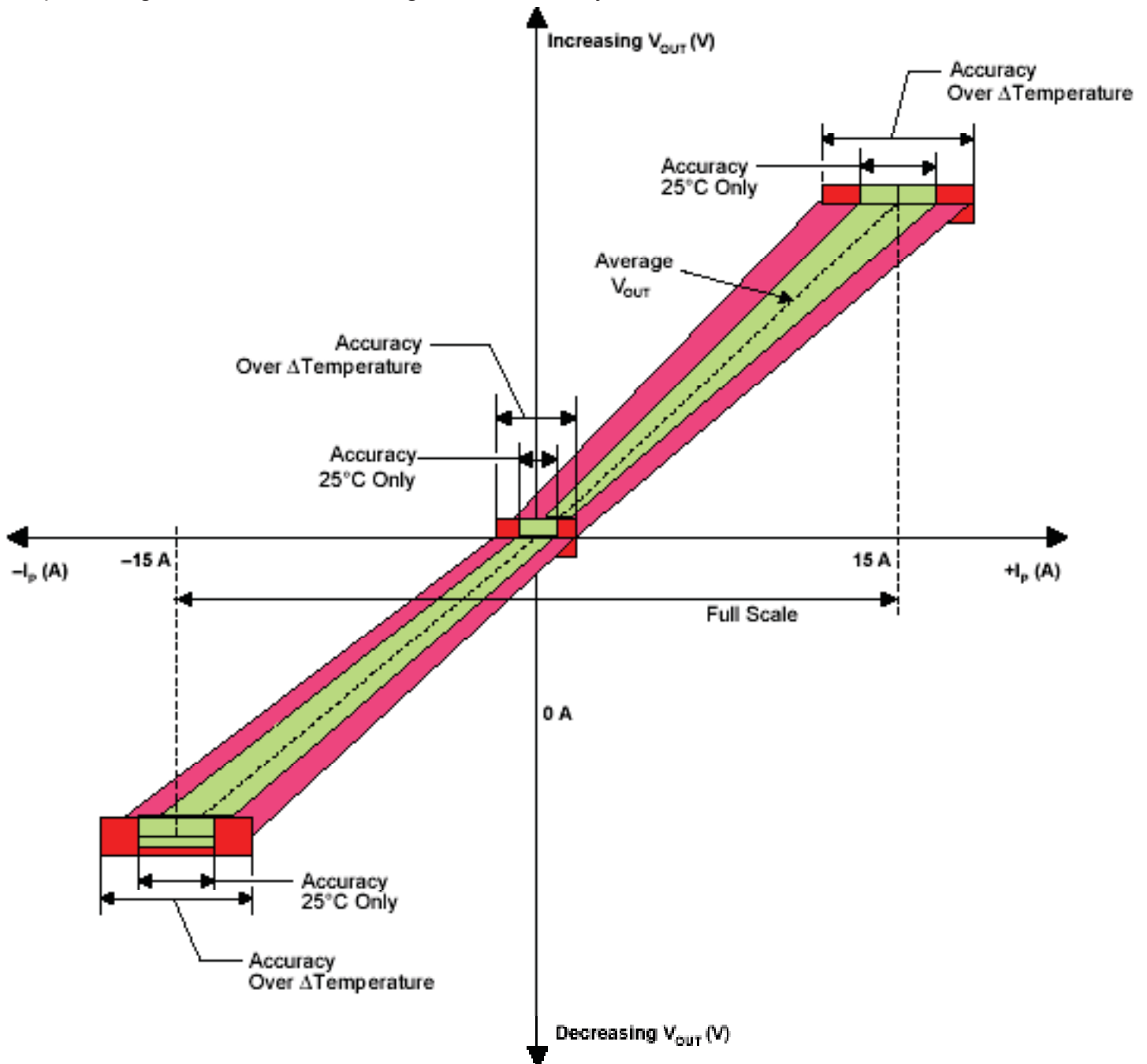

## Definitions of Dynamic Response Characteristics

**Propagation delay ( $t_{PROP}$ ):** The time required for the device output to reflect a change in the primary current signal. Propagation delay is attributed to inductive loading within the linear IC package, as well as in the inductive loop formed by the primary conductor geometry. Propagation delay can be considered as a fixed time offset and may be compensated.

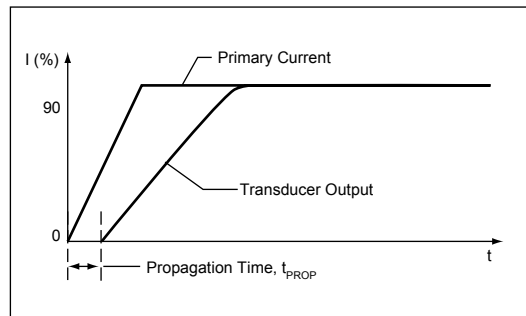

**Response time ( $t_{RESPONSE}$ ):** The time interval between a) when the primary current signal reaches 90% of its final value, and b) when the device reaches 90% of its output corresponding to the applied current.

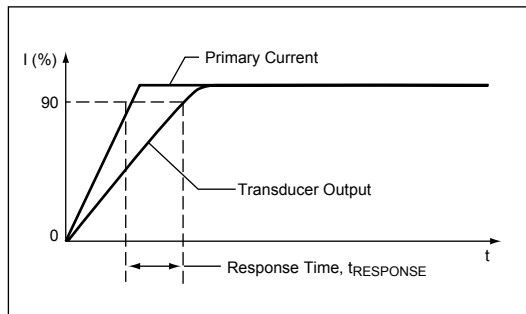

**Rise time ( $t_r$ ):** The time interval between a) when the device reaches 10% of its full scale value, and b) when it reaches 90% of its full scale value. The rise time to a step response is used to derive the bandwidth of the IC, in which  $f(-3 \text{ dB}) = 0.35/t_r$ . Both  $t_r$  and  $t_{RESPONSE}$  are detrimentally affected by eddy current losses observed in the conductive IC ground plane.

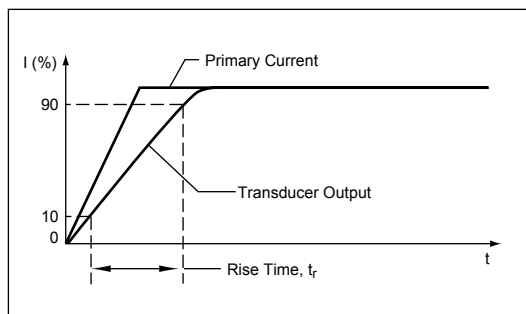

# ACS704ELC-015

## Standards and Physical Specifications

Parameter	Specification
Flammability (package molding compound)	UL recognized to UL 94V-0
Fire and Electric Shock	UL60950-1:2003 EN60950-1:2001 CAN/CSA C22.2 No. 60950-1:2003

## Device Branding Key (Two alternative styles are used)

ACS704T ELC015 YYWWA	ACS	Allegro Current Sensor
	704	Device family number
	T	Indicator of 100% matte tin leadframe plating
	E	Operating ambient temperature range code
	LC	Package type designator
	015	Primary sampled current
	YY	Manufacturing date code: Calendar year (last two digits)
	WW	Manufacturing date code: Calendar week
	A	Manufacturing date code: Shift code
	ACS704T ELC015 L...L YYWW	ACS
704		Device family number
T		Indicator of 100% matte tin leadframe plating
E		Operating ambient temperature range code
LC		Package type designator
015		Primary sampled current
L...L		Manufacturing lot code
YY		Manufacturing date code: Calendar year (last two digits)
WW		Manufacturing date code: Calendar week

# ACS704ELC-015

## Chopper Stabilization Technique

Chopper Stabilization is an innovative circuit technique that is used to minimize the offset voltage of a Hall element and an associated on-chip amplifier. Allegro patented a Chopper Stabilization technique that nearly eliminates Hall IC output drift induced by temperature or package stress effects. This offset reduction technique is based on a signal modulation-demodulation process. Modulation is used to separate the undesired dc offset signal from the magnetically induced signal in the frequency domain. Then, using a low-pass filter, the modulated dc offset is suppressed while the magnetically induced signal passes through the filter. As a result of this chopper stabilization approach, the output voltage from the Hall IC is desensitized to the effects of temperature and mechanical stress. This technique produces devices that have an extremely stable Electrical Offset Voltage, are immune to thermal stress, and have precise recoverability after temperature cycling.

This technique is made possible through the use of a BiCMOS process that allows the use of low-offset and low-noise amplifiers in combination with high-density logic integration and sample and hold circuits.

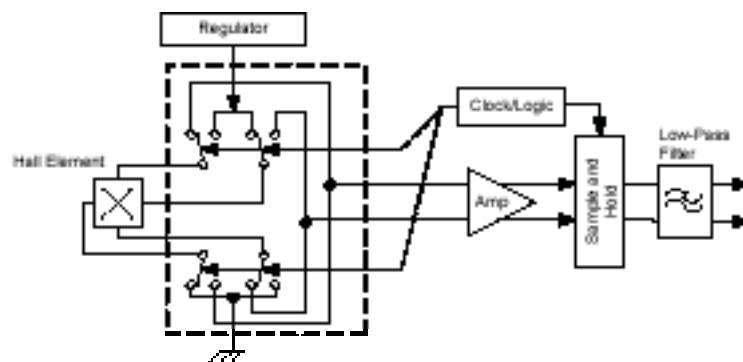

Concept of Chopper Stabilization Technique



# ACS704ELC-015

## Applications Information

### Transient Common-Mode Voltage Rejection in the ACS704

In order to quantify transient common-mode voltage rejection for the ACS704, a device was soldered onto a printed circuit board. A 0.1  $\mu\text{F}$  bypass capacitor and a 5 V dc power supply were connected between VCC and GND (pins 8 and 5) for this device. A 10 k $\Omega$  load resistor and a 0.01  $\mu\text{F}$  capacitor were connected in parallel between the VOUT pin and the GND pin of the device (pins 7 and 5).

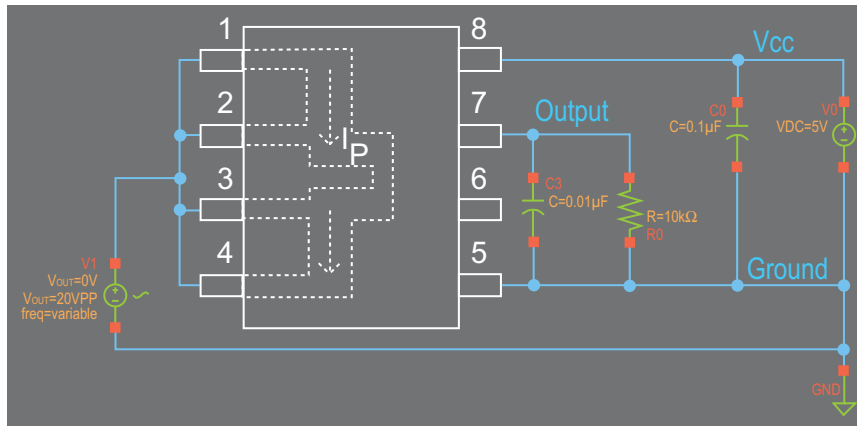

ACS704 Schematic Diagram of the Circuit used to Measure Transient Rejection

A function generator was connected between the primary current conductor (pins 1 thru 4) and the GND pin of the device (pin 5). This function generator was configured to generate a 10 V peak (20 V peak-to-peak) sine wave between pins 1-4 and pin 5. Note that the sinusoidal stimulus was applied such that no electrical current would flow through the copper conductor composed of pins 1-4 of this device.

The frequency of this sine wave was varied from 60 Hz to 5 MHz in discrete steps. At each frequency, the statistics feature of an oscilloscope was used to measure the voltage variations (noise) on the ACS704 output in mV (peak to peak). The noise was measured both before and after the application of the stimulus. Transient common-mode voltage rejection as a function of frequency is shown in the following figure.

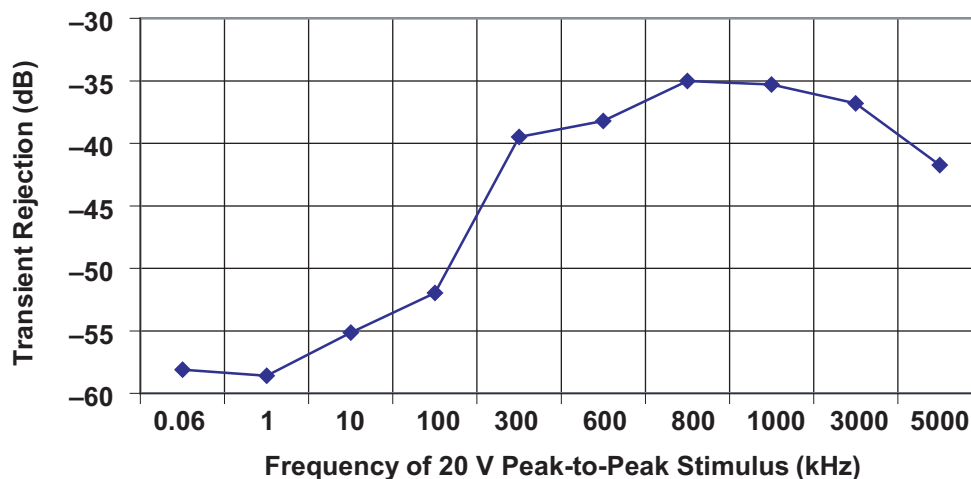

# ACS704ELC-015

## The Effect of PCB Layout on ACS704 Electrical Performance

Eight different PC boards were fabricated to characterize the effect of PCB design on the operating junction temperature of the Hall-effect IC inside of the ACS704. These PC boards are shown in the figure below.

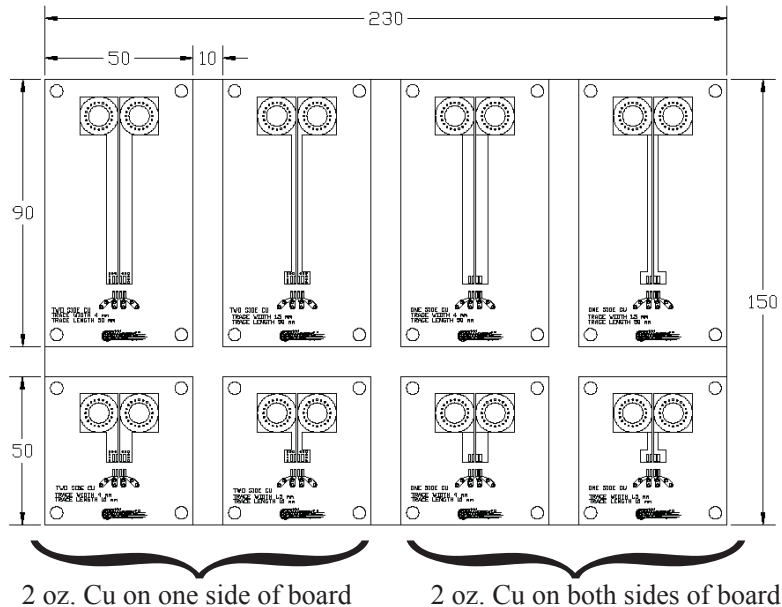

An ACS704 device was soldered onto each PC board before beginning the thermal testing. Thermal management tests were conducted with the following test conditions:

- Tests were conducted at ambient temperature,  $T_a = 20^\circ\text{C}$ . All tests were conducted in still air.
- 14 gauge wires were used to connect a power supply to a single PC board. These wires carry the 15 A dc primary current during the tests.
- A 15 A dc primary current was applied to a single PC board containing an ACS704 device. This current flowed from pins 1 and 2 to pins 3 and 4 of the ACS704 package.
- A 1 mA current was forced from the GND pin to the VCC pin by a Fluke 179 True RMS Multimeter. This was the only power applied to pins 5-8 of the ACS704 package during testing.
- The voltage required to force the 1 mA current from the GND pin to the VCC pin was measured after applying the 15 A primary current for approximately 25 minutes. A graph similar to the graph below was used to determine the junction temperature of the ACS704.

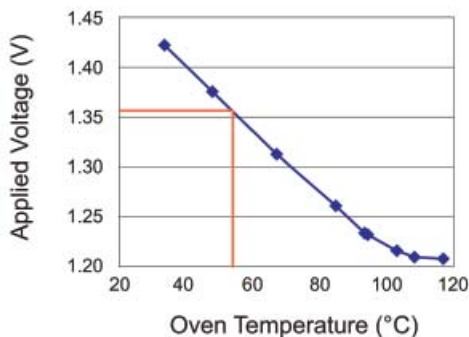

Voltage vs. Temperature Curve used to Determine Die Junction Temperature

# ACS704ELC-015

The results of the testing are shown in the following table.

## Effect of PCB Layout on ACS704 Thermal Performance

Tested at 15A,  $T_A = 20^\circ\text{C}$ , still air, 2 oz. copper traces

PC Boards Sides with Traces	Trace Width (mm)	Trace Length (mm)	Temperature Rise Above Ambient ( $^\circ\text{C}$ )
1	4	50	90
	1.5	50	Overheated
	4	10	48
	1.5	10	110
2	4	50	53
	1.5	50	106
	4	10	38
	1.5	10	54

### Improved PC Board Designs

The eight PC boards in the figure above do not represent an ideal PC board for use with the ACS704. The ACS704 evaluation boards, for sale at the Allegro Web site On-Line Store, represent a more optimal PC board design (see photo below). On the evaluation boards, the current to be sensed flows through very wide traces that were fabricated using 2 layers of 2 oz. copper. Thermal management tests were conducted on the Allegro evaluation boards and all tests were performed using the same test conditions described in the bulleted list above. The results for these thermal tests are shown in the table below. When using the Allegro evaluation boards we see that even at an applied current of 20 A the junction temperature of the ACS704 is only ~30 degrees above ambient temperature.

### ACS704 Thermal Performance on the Allegro Eval PC Boards

Applied Current (A) $T_a = 20^\circ\text{C}$ , Still Air	Temp Rise Above Ambient ( $^\circ\text{C}$ )
15	22
20	31

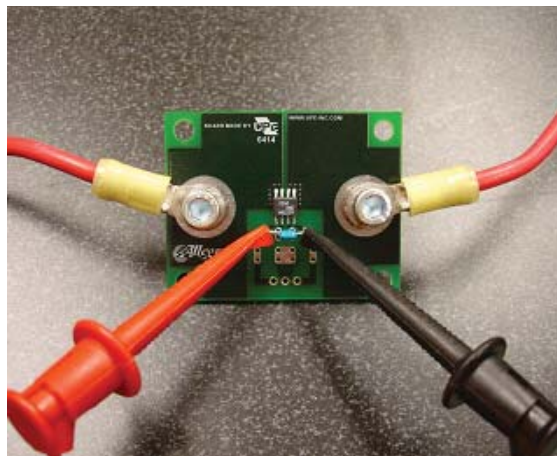

# ACS704ELC-015

## Package LC, 8-pin SOIC

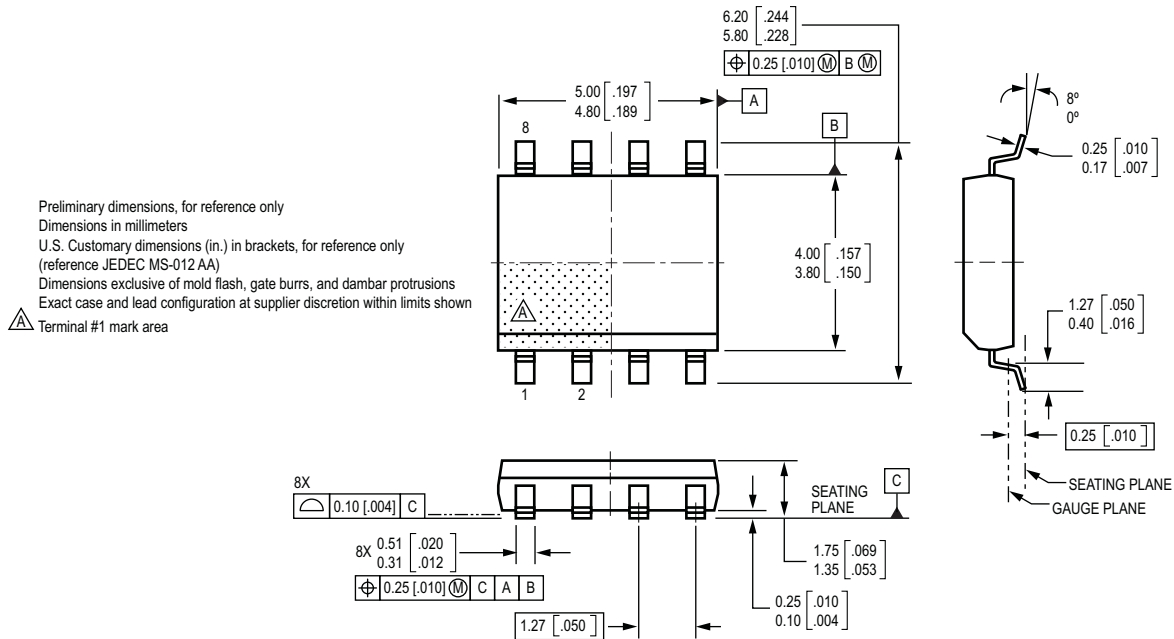

The products described herein are manufactured under one or more of the following U.S. patents: 5,045,920; 5,264,783; 5,442,283; 5,389,889; 5,581,179; 5,517,112; 5,619,137; 5,621,319; 5,650,719; 5,686,894; 5,694,038; 5,729,130; 5,917,320; and other patents pending.

Allegro MicroSystems, Inc. reserves the right to make, from time to time, such departures from the detail specifications as may be required to permit improvements in the performance, reliability, or manufacturability of its products. Before placing an order, the user is cautioned to verify that the information being relied upon is current.

Allegro products are not authorized for use as critical components in life-support devices or systems without express written approval.

The information included herein is believed to be accurate and reliable. However, Allegro MicroSystems, Inc. assumes no responsibility for its use; nor for any infringement of patents or other rights of third parties which may result from its use.

Copyright©2005, 2006, Allegro MicroSystems, Inc.