

## CRD15DD17P

Wide Input Voltage Range (300VDC-1200VDC) 15W Flyback Auxiliary Power Supply Board

## CRD15DD17P

宽电压输入范围(300VDC-1200VDC)15W 反激式辅助电源板

## CRD15DD17P

ワイド入力電圧範囲(300VDC-1200VDC)15W 帰線補助電源ボード



## Application Note

CPWR-AN22, Rev-

Cree Power Applications

Cree, Inc.  
4600 Silicon Drive  
Durham, NC 27703 USA

科税有限责任公司  
4600 硅驱动器  
Durham, NC 27703 USA

クリー株式会社  
4600 シリコンドライブ  
Durham, NC 27703 USA

*This document is prepared as an application note to install and operate Cree evaluation hardware.*

All parts of this application note are provided in English, and the Cautions are provided in English, Mandarin, and Japanese. If the end user of this board is not fluent in any of these languages, it is your responsibility to ensure that they understand the terms and conditions described in this document, including without limitation the hazards of and safe operating conditions for this board.

本文件中的所有内容均以英文书写，“注意”部分的内容以英文、中文和日语书写。若本板子的终端用户不熟悉上述任何一种语言，则您应当确保该终端客户能够理解本文件中的条款与条件，包括且不限于本板子的危险以及安全操作条件。

当書類のすべての内容は英語で書きます。「注意点」の内容は英語、中国語、また日本語で書きます。当ボードの端末使用者は上記の言語が一つでもわからないなら、当端末使用者は当書類の条約と条件が理解できるのを確保すべきです。そして、当ボードの危険や安全に使用する条件を含み、また限りません。

**Note:** This Cree-designed evaluation hardware for Cree components is a fragile, high voltage, high temperature power electronics system that is meant to be used as an evaluation tool in a lab setting and to be handled and operated by highly qualified technicians or engineers. When this hardware is not in use, it should be stored in an area that has a storage temperature ranging from -40° Celsius to 150° Celsius and if this hardware is transported, special care should be taken during transportation to avoid damaging the board or its fragile components and the board should be transported carefully in an electrostatic discharge (ESD) bag to avoid any damage to electronic components. The hardware does not contain any hazardous substances, is not designed to meet any industrial, technical, or safety standards or classifications, and is not a production qualified assembly.

本工具（一种易碎、高压、高温电力电子系统）是由科锐为其组件设计的评估硬件，旨在用作实验室环境下的评估工具，并由够格的技术人员或工程师处理和操作。本硬件不使用时，应存储在-40oC到150oC温度范围的区域内；如需运输本硬件，运输过程中应该特别小心，避免损坏电路板或其易碎组件。电路板应放置在静电放电（ESD）袋中谨慎运输，避免损坏电子组件。本硬件不含任何有害物质，其设计不符合任何工业、技术或安全标准或分类，也不是可用于生产的组件。

このクリーのコンポーネント用評価ハードウェアは壊れやすい高電圧の高温パワーエレクトロニクスシステムであり、ラボ環境での評価ツールとして使用され、優秀な技術者やエンジニアによって処理され、操作されることを意図している。ハードウェアが使用されていない場合、保管温度が-40℃から150℃の範囲に保管してください。このハードウェアを輸送する場合は、輸送中にボードまたはその壊れやすいコンポーネントに損傷を与えないよう特別な注意を払う必要がある。また電子部品の損傷を避けるためにボードを静電気放電(ESD)袋に静置して慎重に輸送すべき。ハードウェアには危険物質が含まれていないが、工業的、技術的、安全性の基準または分類に適合するように設計されておらず、生産適格組立品でもない。

## CAUTION

**PLEASE CAREFULLY REVIEW THE FOLLOWING PAGE, AS IT CONTAINS IMPORTANT INFORMATION REGARDING THE HAZARDS AND SAFE OPERATING REQUIREMENTS RELATED TO THE HANDLING AND USE OF THIS BOARD.**

## 警告

请认真阅读以下内容，因为其中包含了处理和**使用本板子有关的危险和安全操作要求**方面的重要信息。

## 警告

ボードの使用、危険の対応、そして安全に操作する**要求などの大切な情報を含む**ので、以下の内容をよく読んでください。



## CAUTION

**DO NOT TOUCH THE BOARD WHEN IT IS ENERGIZED AND ALLOW THE BULK CAPACITORS TO COMPLETELY DISCHARGE PRIOR TO HANDLING THE BOARD. THERE CAN BE VERY HIGH VOLTAGES PRESENT ON THIS EVALUATION BOARD WHEN CONNECTED TO AN ELECTRICAL SOURCE, AND SOME COMPONENTS ON THIS BOARD CAN REACH TEMPERATURES ABOVE 50° CELSIUS. FURTHER, THESE CONDITIONS WILL CONTINUE FOR A SHORT TIME AFTER THE ELECTRICAL SOURCE IS DISCONNECTED UNTIL THE BULK CAPACITORS ARE FULLY DISCHARGED.**

**Please ensure that appropriate safety procedures are followed when operating this board, as any of the following can occur if you handle or use this board without following proper safety precautions:**

- **Death**
- **Serious injury**
- **Electrocution**
- **Electrical shock**
- **Electrical burns**
- **Severe heat burns**

You must read this document in its entirety before operating this board. It is not necessary for you to touch the board while it is energized. All test and measurement probes or attachments must be attached before the board is energized. You must never leave this board unattended or handle it when energized, and you must always ensure that all bulk capacitors have completely discharged prior to handling the board. Do not change the devices to be tested until the board is disconnected from the electrical source and the bulk capacitors have fully discharged.

## 警告

请勿在通电情况下接触板子，在处理板子前应使大容量电容器完全释放电力。接通电源后，该评估板上可能存在非常高的电压，板子上一些组件的温度可能超过 50 摄氏度。此外，移除电源后，上述情况可能会短暂持续，直至大容量电容器完全释放电量。

操作板子时应确保遵守正确的安全规程，否则可能会出现下列危险：

- 死亡
- 严重伤害
- 触电
- 电击
- 电灼伤
- 严重的热烧伤

请在操作本板子前完整阅读本文件。通电时不必接触板子。在为板子通电前必须连接所有测试与测量探针或附件。通电时，禁止使板子处于无人看护状态，或操作板子。必须确保在操作板子前，大容量电容器释放了所有电量。只有在切断板子电源，且大容量电容器完全放电后，才可更换待测试器件

## 警告

通電している時、ボードに接触するのは禁止です。ボードを処分する前に、大容量のコンデンサーで電力を完全に解放すべきです。通電してから、ボードにひどく高い電圧が存在している可能性があります。ボードのモジュールの温度は 50 度以上になるかもしれません。また、電源を切った後、上記の状況がしばらく持続する可能性がありますので、大容量のコンデンサーで電力を完全に解放するまで待ってください。

ボードを操作するとき、正確な安全ルールを守るのを確保すべきです。さもないと、以下の危険がある可能性があります：

- 死亡
- 重症
- 感電
- 電撃
- 電気の火傷
- 厳しい火傷

当ボードを操作する前に、完全に当書類をよく読んでください。通電している時にボードに接触する必要がありません。通電する前に必ずすべての試験用のプローブあるいはアクセサリーをつないでください。通電している時に無人監視やボードを操作するのは禁止です。ボードを操作する前に、大容量のコンデンサーで電力を完全に解放するのを必ず確保してください。ボードの電源を切った後、また大容量のコンデンサーで電力を完全に解放した後、試験設備を取り換えることができます。

## Table of Contents

1. Introduction.....	7
2. Design Specifications .....	8
3. Physical Dimensions and Pinouts .....	8
4. Electrical Operation .....	9
5. Performance Data .....	13
6. PCB Layout and Bill of Materials (BOM) .....	19
7. Revision History .....	20

## 1. Introduction

For high power and high voltage applications including solar inverters, energy storage systems, and traction application, the DC input can be as high as 1200VDC and AC input can be within the range of 480 VAC to 530VAC. Low power subsystems that support these high power and high voltage systems (such as cooling fans, displays, and controller biasing) must have a low power auxiliary power supply that can take high voltage input (AC or DC) and can generate low DC voltage at the output.

The topology that is most commonly used in the industry for these low power subsystems is the flyback topology. In the present market, silicon based MOSFETs are widely used power switching devices for flyback converters. However, as compared to silicon carbide (SiC) MOSFETs, most silicon based MOSFETs have 1500V (max) blocking voltage with a low design margin of voltage stress (which has significant impact on the reliability of the power supply) and a very large on-state resistance ( $R_{ds(on)}$ ), which leads to higher power loss, lower efficiency and high thermal stress.

In this application note, Cree has introduced a wide input range (300V-1200V), 15 W flyback auxiliary power supply board (P/N: CRD15DD17P) based on Cree's C2M1000170J, 1700V, 1000 m $\Omega$ , (TO-263-7) silicon carbide (SiC) MOSFET. The designed flyback converter can accept 480VAC - 530VAC or 300 VDC - 1200 VDC input to provide 12 VDC at the output.

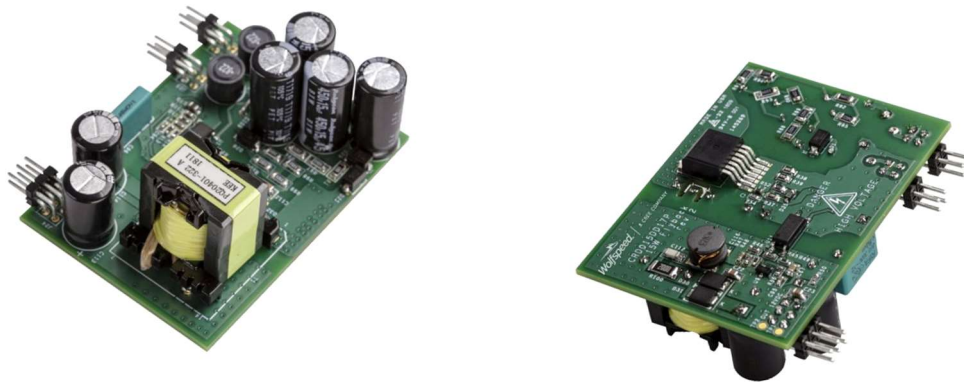

Figure 1. Cree's CRD15DD17P, 15 W flyback auxiliary power supply board



## 2. Design Specifications

The design specifications of Cree’s CRD15DD17P, 15 W flyback auxiliary power supply board are listed in Table 1.

Parameters	Values
Input voltage range, 50-60Hz	480 VAC - 530 VAC or 300 VDC - 1200 VDC
Output voltage	12 VDC
Output Current	1.3 A
Output Power	15 W
Switching frequency	100 kHz (max)
Efficiency	> 85%
Max ambient operating temperature	50 °C
Topology	Single-end Flyback
Power device package	TO-263-7

*Table 1: Design Specifications of Cree’s CRD15DD17P, 15 W flyback auxiliary power supply board*

## 3. Physical Dimensions and Pinouts

The Physical dimensions and the pinouts of Cree’s CRD15DD17P, 15 W flyback auxiliary power supply board have been shown in Figure 2.



Figure 2. Physical Dimensions and Pinouts of Cree's CRD15DD17P, 15 W flyback auxiliary power supply board

## 4. Electrical Operation



### CAUTION

\*\*\*HIGH VOLTAGE RISK\*\*\*

THERE CAN BE VERY HIGH VOLTAGES PRESENT ON THIS BOARD WHEN CONNECTED TO AN ELECTRICAL SOURCE, AND SOME COMPONENTS ON THIS BOARD CAN REACH TEMPERATURES ABOVE 50° CELSIUS. FURTHER, THESE CONDITIONS WILL CONTINUE AFTER THE ELECTRICAL SOURCE IS DISCONNECTED UNTIL THE BULK CAPACITORS ARE FULLY DISCHARGED. DO NOT TOUCH THE BOARD WHEN IT IS ENERGIZED AND ALLOW THE BULK CAPACITORS TO COMPLETELY DISCHARGE PRIOR TO HANDLING THE BOARD.

The connectors on the board have very high voltage levels present when the board is connected to an electrical source, and thereafter until the bulk capacitors are fully discharged. Please ensure that appropriate safety procedures are followed when working with these connectors as serious injury, including death by electrocution or serious injury by electrical shock or electrical burns, can

occur if you do not follow proper safety precautions. When devices are being attached for testing, the board must be disconnected from the electrical source and all bulk capacitors must be fully discharged. After use the board should immediately be disconnected from the electrical source. After disconnection any stored up charge in the bulk capacitors will continue to charge the connectors. Therefore, you must always ensure that all bulk capacitors have completely discharged prior to handling the board.

## 警告

**\*\*\*高压危险\*\*\***

接通电源后，该评估板上可能存在非常高的电压，板子上一些组件的温度可能超过 50 摄氏度。此外，移除电源后，上述情况可能会短暂持续，直至大容量电容器完全释放电量。通电时禁止触摸板子，应在大容量电容器完全释放电量后，再触摸板子。

板子上的连接器在充电时以及充电后都具有非常高的电压，直至大容量电容器完全释放电量。请确保在操作板子时已经遵守了正确的安全流程，否则可能会造成严重伤害，包括触电死亡、电击伤害或电灼伤。连接器件进行测试时，必须切断板子电源，且大容量电容器必须释放了所有电量。使用后应立即切断板子电源。切断电源后，大容量电容器中存储的电量会继续输入至连接器中。因此，必须始终在操作板子前，确保大容量电容器已完全释放电量。

## 警告

**\*\*\*高压危险\*\*\***

通电してから、ボードにひどく高い電圧が存在している可能性があります。ボードのモジュールの温度は50度以上になるかもしれません。また、電源を切った後、上記の状況がしばらく持続する可能性がありますので、大容量のコンデンサーで電力を完全に釈放するまで待ってください。通电している時にボードに接触するのは禁止で

す。大容量のコンデンサーで電力をまだ完全に釈放していない時、ボードに接触しないでください。ボードのコネクターは充電中また充電した後、ひどく高い電圧が存在しているため、大容量のコンデンサーで電力を完全に釈放するまで待ってください。ボードを操作している時、正確な安全ルールを守っているのを確保してください。さもなければ、感電、電撃、厳しい火傷などの死傷が出る可能性があります。設備をつないで試験する時、必ずボードの電源を切ってください。また、大容量のコンデンサーで電力を完全に釈放してください。使用後、すぐにボードの電源を切ってください。電源を切った後、大容量のコンデンサーに貯蓄している電量はコネクターに持続的に入るので、ボードを操作する前に、必ず大容量のコンデンサーの電力を完全に釈放するのを確保してください

Cree's CRD15DD17P, 15 W flyback auxiliary power supply board is based on Cree's C2M1000170J, 1700V, 1000 mΩ, TO-263-7 SiC MOSFET (as shown in Figure 3). Cree's C2M1000170J SiC MOSFET consists of a fast-intrinsic diode with low reverse recovery charge (Qrr) and a very low output capacitance. Cree's C2M1000170J SiC MOSFET comes in a compact surface mount package with extended leads for high voltage capability and low source inductance.

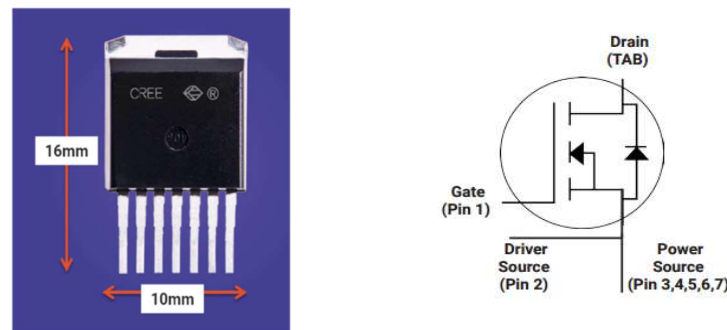

Figure 3: Cree's C2M1000170J SiC MOSFET in a TO-263-7 package

A Texas Instruments Inc. flyback controller (P/N: UCC28740) (as shown in Figure 4) has been utilized in Cree's CRD15DD17P, 15 W flyback auxiliary power supply board. This controller contains less than 10 mW no load power capability, optocoupled feedback for constant voltage (CV) mode and primary side regulation for constant current (CC) mode (which enable +/- 1% voltage regulation across line and load), a 700 V start-up switch, valley switching operation for

high overall efficiency, frequency dithering to ease electromagnetic interference (EMI) compliance, a clamped gate drive output for the MOSFET, and overvoltage, low line, and overcurrent protection function.

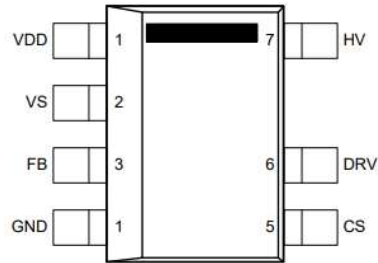

Figure 4: Cree’s Flyback controller IC (P/N: UCC28740) from Texas Instruments Inc.

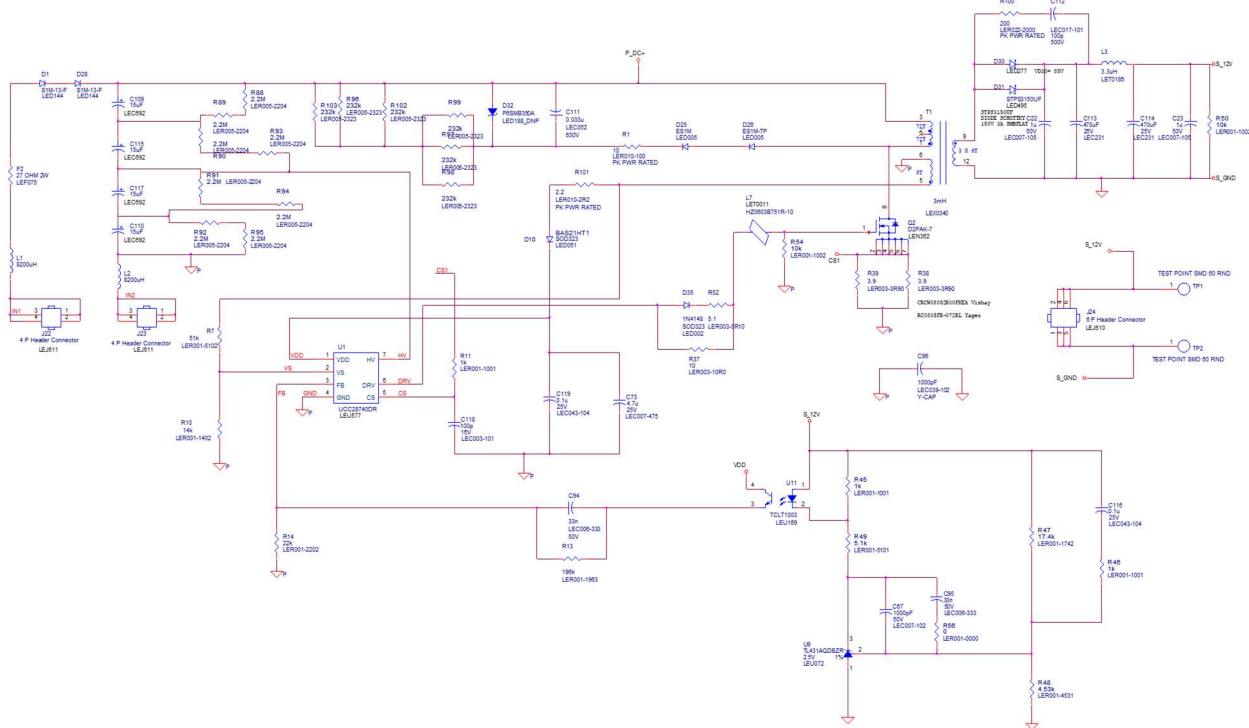

Figure 5: Schematic of Cree’s CRD15DD17P, 15 W flyback auxiliary power supply board

(\*Note: A larger copy of this schematic may be obtained upon request by contacting Cree at [sic\\_power@cree.com](mailto:sic_power@cree.com))

Cree's CRD15DD17P, 15 W flyback auxiliary power supply board accepts both AC and DC input (as shown in Figure 5). If the type of input is AC, diodes D1 and D28 serve as input voltage rectifiers and DC voltage is established across the four aluminum capacitors C109, C110, C105 and C107. The inductors L1 and L2 are used for EMI suppression. A fusible resistor F2 is used to reduce the charging current and will open when there is an over current condition due to a malfunction in the circuit. The midpoint between capacitors C115 and C117 has half the rectified DC input voltage, so the maximum voltage that controller U1 will experience at its HV pin (as shown in Figure 4) would be 600 VDC for 1200 VDC input, which is below the 700 V rating. The voltage at this midpoint provides an initial charging current via controller U1's built-in high-voltage start-up switch until VDD pin (as shown in Figure 4) reaches the turn-on voltage of controller U1. Once controller U1 starts switching the primary side's main switch, voltage VDD will be maintained via auxiliary winding (5-6) of the flyback transformer, and the internal switch that provides start-up current in controller U1 will be turned off to reduce power loss.

Before powering up Cree's CRD15DD17P, 15 W flyback auxiliary power supply board, a user should place a sheet of insulation material (not included) underneath the board to avoid any unintended electrical short conditions. After the power is applied to Cree's CRD15DD17P, 15 W flyback auxiliary power supply board, the output could be measured by using a 12 VDC digital multimeter (DMM) or by using an oscilloscope.

If the type of input is DC (i.e., for applications with less than 1000 VDC), only two snubber resistors, R96 and R97 (as shown in Figure 5), can be used on Cree's CRD15DD17P, 15 W flyback auxiliary power supply board to improve efficiency. To power up Cree's CRD15DD17P, 15 W flyback auxiliary power supply board with 300 VDC – 1000 VDC input, replace R90, R91, R93 and R94 (as shown in Figure 5) with 0Ω resistors to short capacitors C115 and C117 (as shown in Figure 5).

## 5. Performance data

### I. Voltage regulation

Cree's CRD15DD17P, 15 W flyback auxiliary power supply board was tested under various load conditions and at various input voltage levels. Under all those conditions, the voltage regulation of Cree's CRD15DD17P, 15 W flyback auxiliary power supply board was well within 0.25 % (as shown in Figure 6).

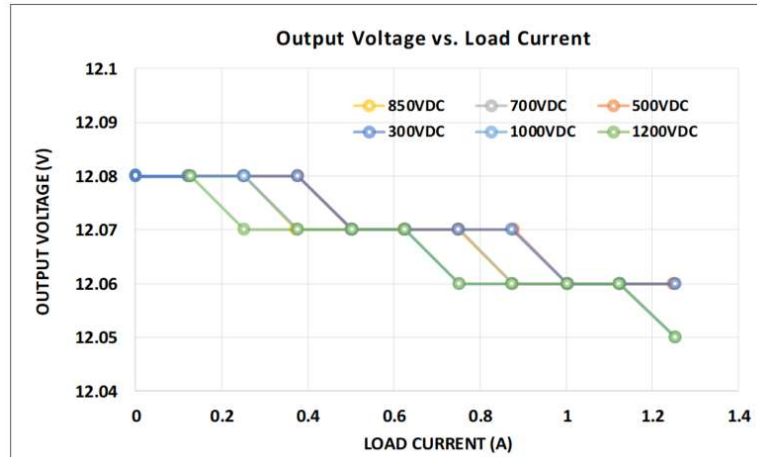

Figure 6: Voltage regulation data of Cree’s CRD15DD17P, 15 W flyback auxiliary power supply board

## II. EMI

The conducted EMI of Cree’s CRD15DD17P, 15 W flyback auxiliary power supply board was measured at full load while the input voltage remained at 277 VAC (as shown in Figure 7). During these conditions, Cree’s CRD15DD17P, 15 W flyback auxiliary power supply board passed the Federal Communications Commission Part 15 Class A standard for commercial applications.

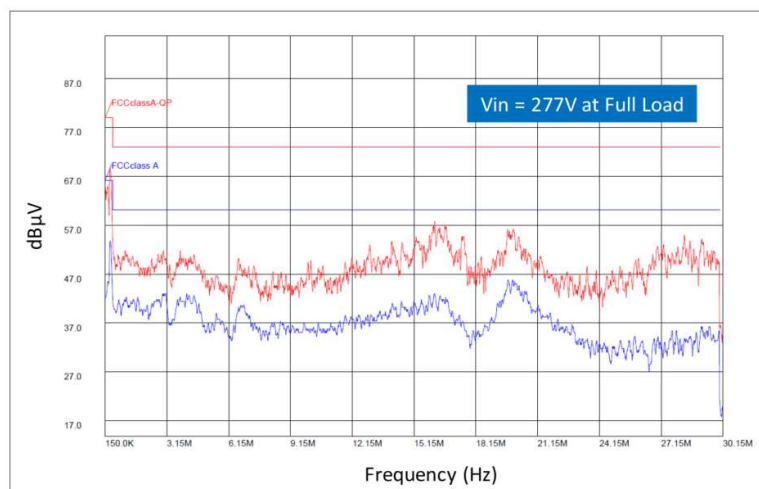

Figure 7: Conducted EMI measurement of Cree’s CRD15DD17P, 15 W flyback auxiliary power supply board at full load while the input voltage remained at 277 VAC

CPWR-AN22, Rev -, 05-2018

Copyright © 2018 Cree, Inc. All rights reserved.

The information in this document is subject to change without notice.

Cree, the Cree logo, and Zero Recovery are registered trademarks of Cree, Inc.

### III. Efficiency

The efficiency of Cree’s CRD15DD17P, 15 W flyback auxiliary power supply board was tested under various operating conditions (as shown in Figure 8 and Figure 9). These measurements were taken at 300 V, 500 V, 850 V, 1100 V and 1200 V DC input voltage levels and the peak efficiency achieved at each input voltage was 85% at 300 VDC, 84% at 500 VDC, 80% at 850 VDC, 70.8 % at 1100 VDC, and 70% at 1200 VDC.

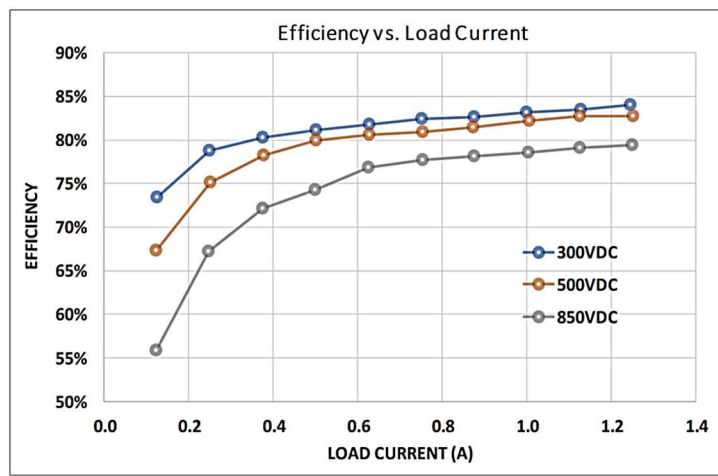

Figure 8: Efficiency measurements of Cree’s CRD15DD17P, 15 W flyback auxiliary power supply board at 300 VDC, 500 VDC and 850 VDC input

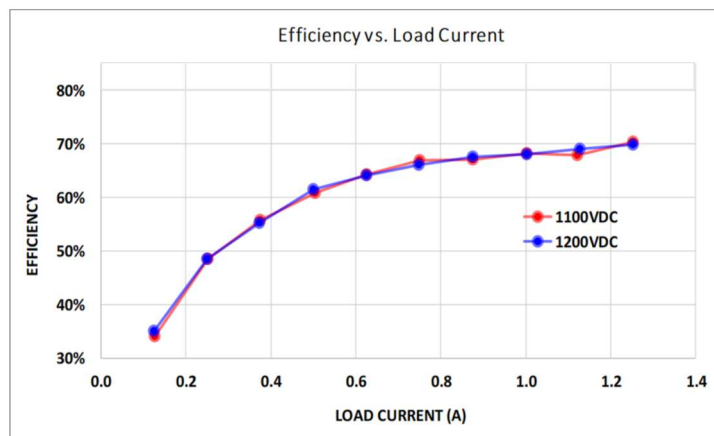

Figure 9: Efficiency measurements of Cree’s CRD15DD17P, 15 W flyback auxiliary power supply board at 1100 VDC and 1200 VDC input



#### IV. Waveforms at various operating conditions

The performance of Cree’s CRD15DD17P, 15 W flyback auxiliary power supply board can be evaluated by using start-up waveforms of output voltage at each of 300 VDC and 1200 VDC taken at full-load and open load conditions (as shown in Figures 10(a) and 10(b) and Figures 11(a) and 11(b)). The waveforms of output voltage both at full load and open load conditions show very low overshoot and low ripples.

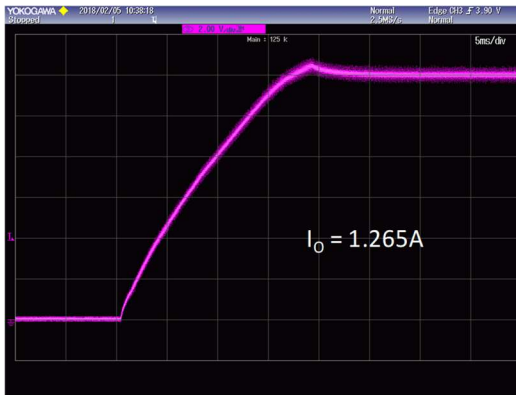

Figure 10 (a)

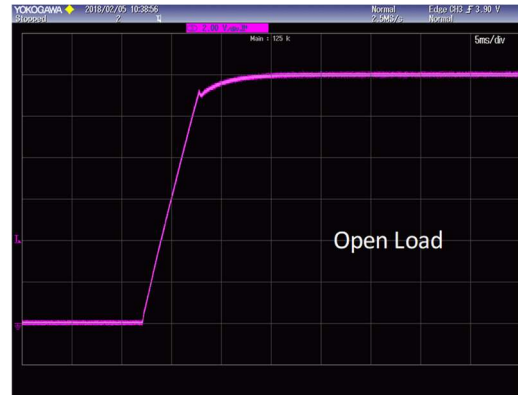

Figure 10 (b)

Figure 10 (a): Start-up waveform of output voltage at 300 VDC input and full load

Figure 10 (b): Start-up waveform of output voltage at 300 VDC input at open load

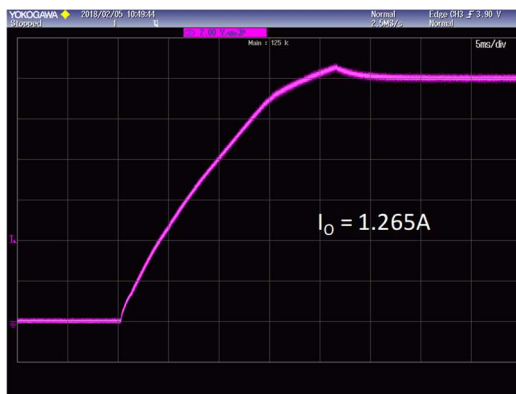

Figure 11 (a)

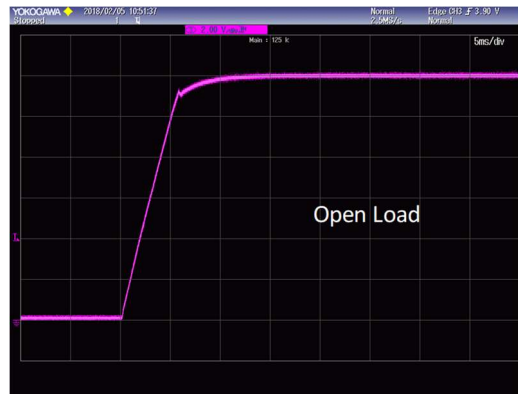

Figure 11 (b)

Figure 11 (a): Start-up waveform of output voltage at 1200 VDC input and full load

Figure 11 (b): Start-up waveform of output voltage at 1200 VDC input at open load

In addition to start-up waveforms of output voltage, drain-source voltage ( $V_{DS}$ ) and gate-source voltage ( $V_{GS}$ ) waveforms (as shown in Figures 12(a) and 12(b)) can also be used to evaluate the performance of Cree’s CRD15DD17P, 15 W flyback auxiliary power supply board. As illustrated in Figures 12(a) and 12(b),  $V_{GS}$  waveform is free from gate ringing,  $V_{DS}$  waveform has peak voltage of 1600 V (which is less than the rated voltage of Cree’s C2M1000170J, 1700V, 1000 m $\Omega$ , TO-263-7 SiC MOSFET), and both  $V_{DS}$  and  $V_{GS}$  waveforms have negligible deadtime in between them to reduce the switching losses.

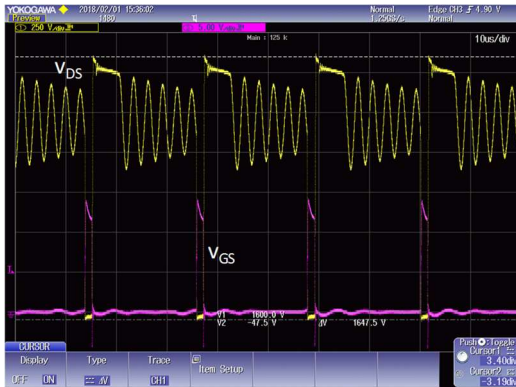

Figure 12 (a)

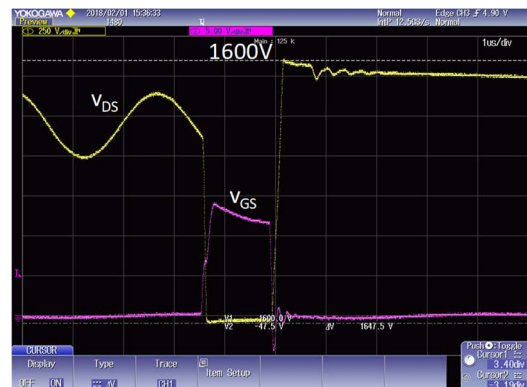

Figure 12 (b)

Figure 12 (a): Gate-source ( $V_{GS}$ ) and drain-source voltage ( $V_{DS}$ ) waveforms at 1200 VDC input

Figure 12 (b): Single pulse view of gate-source ( $V_{GS}$ ) and drain-source voltage ( $V_{DS}$ ) waveforms at 1200 VDC input

## V. Thermal Measurements

Thermal measurements of Cree’s CRD15DD17P, 15 W flyback auxiliary power supply board were taken at various line voltages and load conditions. These measurements were well below the rated temperature range as shown in Figures 13-18.

Cree’s CRD15DD17P, 15 W flyback auxiliary power supply board has large copper pads available on both sides of the board interconnected through vias (as shown in Figure 19-20). These vias have been used for Cree’s C2M1000170J, 1700V, 1000 m $\Omega$ , TO-263-7 SiC MOSFET and snubber resistors on the primary side of the board. The copper pads are not isolated from the drain tab of the MOSFET and will therefore become electrically hot. The snubber resistors will also get hot, but more copper has been added into the copper pads to mount snubber resistors further apart from each other to reduce their temperature. The maximum temperature of Cree’s C2M1000170J, 1700V, 1000 m $\Omega$ , TO-263-7 SiC MOSFET measured at 1.2 kVDC input and full load is 103 °C.

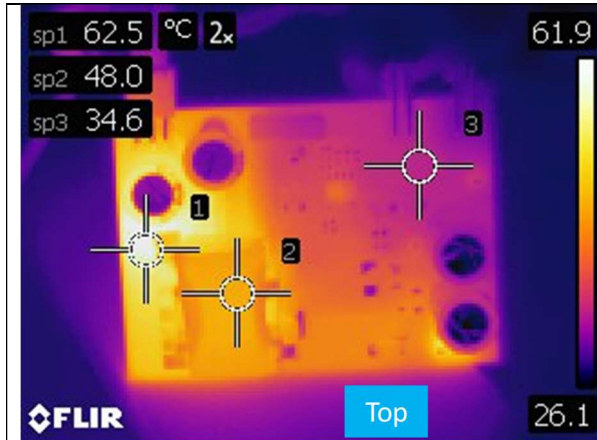

Figure 13. Thermal image of top layer at 300VDC input and full load

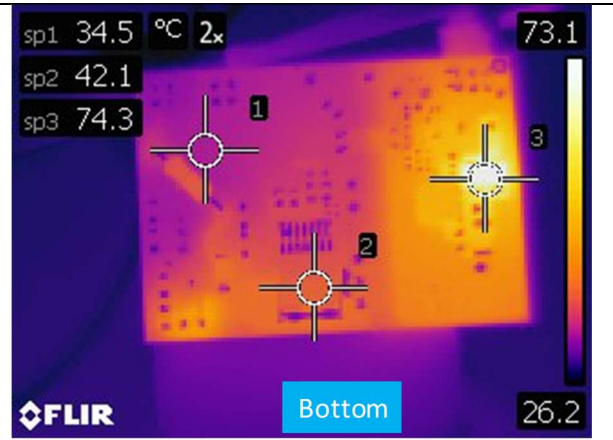

Figure 14. Thermal image of bottom layer at 300VDC input and full load

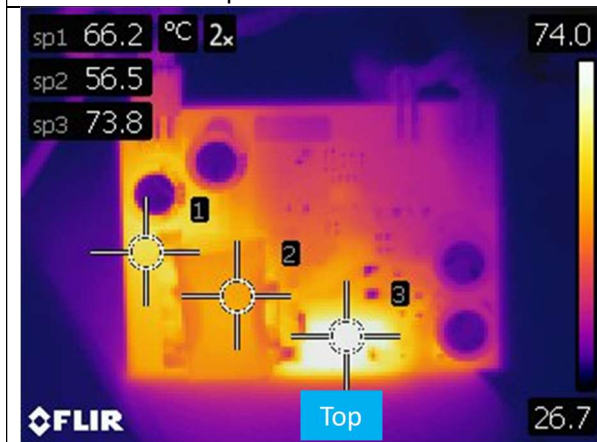

Figure 15. Thermal image of top layer at 850VDC input and full load

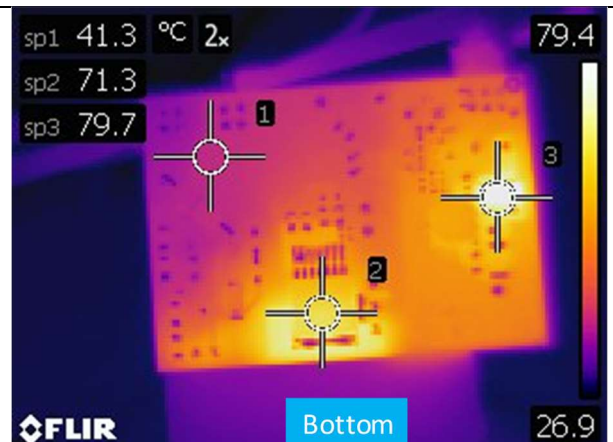

Figure 16. Thermal image of bottom layer at 850VDC input and full load

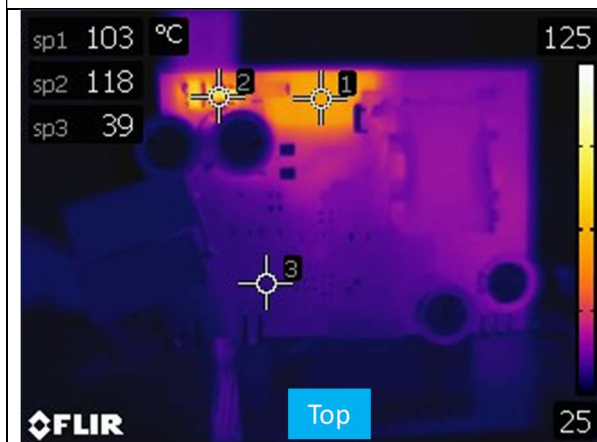

Figure 17. Thermal image of top layer at 1.2kVDC input and full load

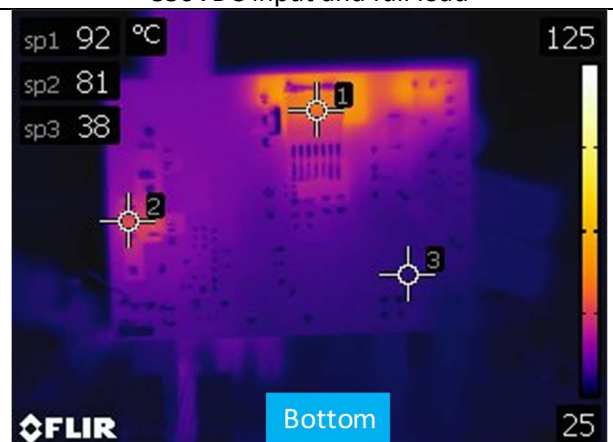

Figure 18. Thermal image of bottom layer at 1.2kVDC input and full load

### 6. PCB Layout and Bill of Materials (BOM)

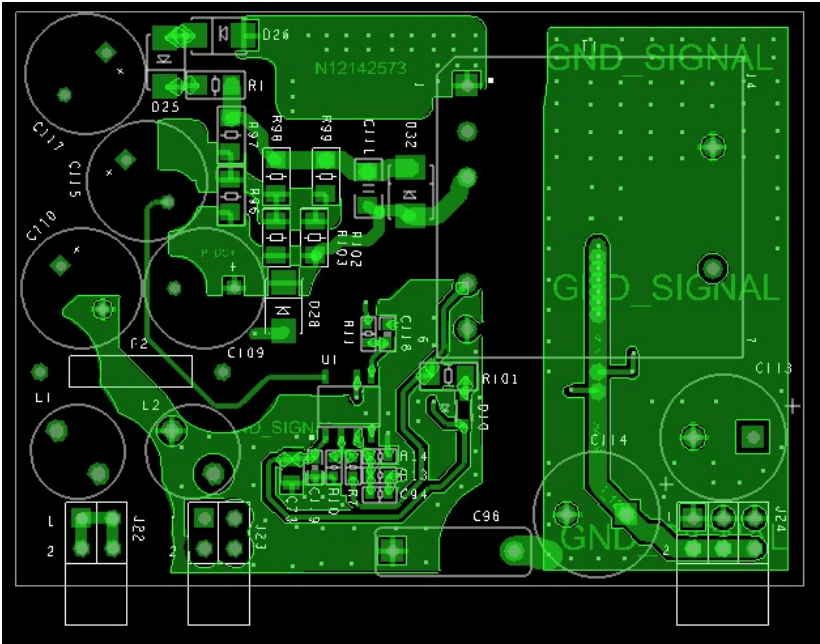

Figure 19. Top layer of the PCB

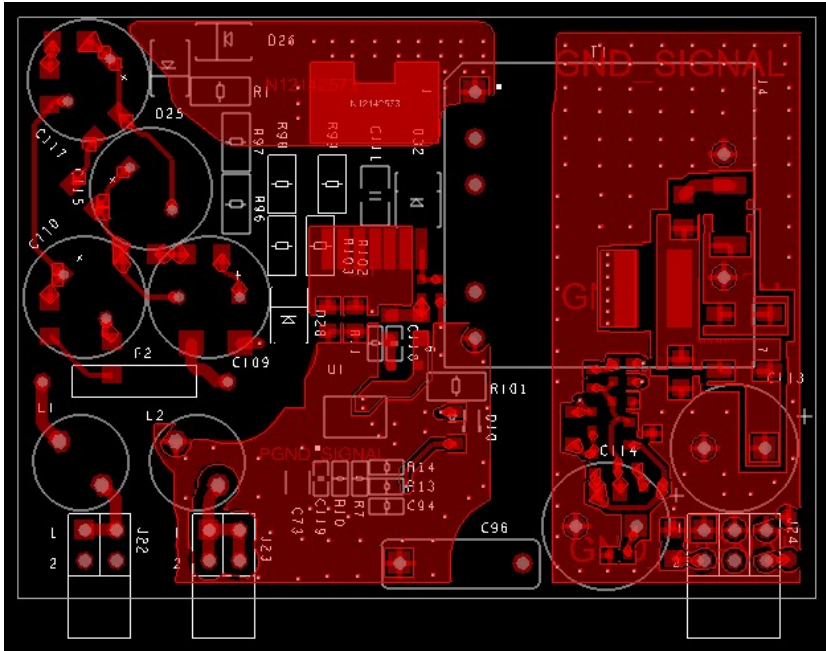

Figure 20. Bottom layer of the PCB

CPWR-AN22, Rev - , 05-2018  
 Copyright © 2018 Cree, Inc. All rights reserved.  
 The information in this document is subject to change without notice.  
 Cree, the Cree logo, and Zero Recovery are registered trademarks of Cree, Inc.

Item	Qty Per	Reference designat	Description	Manufacturer Name	Manufacturer P/N
1	2	C22,C23	CAP CER 1µF 50V X7R 0805	Murata Electronics North America	GRM21BR71H105KA12L
2	1	C67	CAP CER 1000pF 50V 10% 0805 X7R	KEMET	C0805C102K5RACTU
3	1	C73	CAP CER 4.7µF 25V X7R 0805	Taiyo Yuden	TMK212AB7475KG-T
4	2	C94,C95	CAP CER 0.033µF 50V X7R 0603	AVX CORP.	06035C333KAT2A
5	1	C96	CAP FILM 1000pF 20% 1.25kVDC RAD	KEMET	PHE850EA4100MA01R17
6	4	C115,C117,C109,C110	CAP ALUM 15µF 20% 450V RADIAL	Rubycon	450BXW15MEFC10X20
7	1	C111	CAP CER 0.033µF 630V X7R 1206	TDK Corporation	C3216X7R2J333K160AA
8	1	C112	CAP CER 100pF 500V X7R 1206	KEMET	C1206C101KCRACTU
9	2	C113,C114	CAP ALUM 470µF 20% 25V RADIAL	Panasonic Electronic Components	EEU-EB1E471
10	1	C118	CAP CER 100PF 16V X7R 0603	AVX Corporation	0603YC101KAT2A
11	2	C116, C119	CAP CER 0.1µF 25V X7R 0603	Murata Electronics North America	GRM188R71E104KA01D
12	1	D10	DIODE GEN PURP 250V 200mA SOD323	ON Semiconductor	BAS21HT1G
13	2	D25,D26	DIODE GEN PURP 1kV 1A DO214AC	MICRO COMMERCIAL COMPONENT	ES1M-TP
14	2	D1,D28	DIODE GEN PURP 1KV 1A SMA	Diodes Incorporated	S1M-13-F
15	1	D30,D31	DIODE SCHOTTKY 150V 3A SMBFLAT	STMicroelectronics	STPS3150UF
16	1	D35	DIODE GEN PURP 75V 150mA SOD323	MICRO COMMERCIAL COMPONENT	1N4148WXTPMSTR
17	1	F2	Metal Film Resistor Through Hole 2W 27 ohm 10% FUSIBLE	TT ELECTRONICS	EMC2-27RKI
18	2	J22,J23	4 Positions Header Connector, 0.100" (2.54mm), Through Hole, Right Angle, Tin	SAMTEC INC USA	TSW-102-09-T-D-RA
19	1	J24	6 Positions Header Connector, 0.100" (2.54mm), Through Hole, Right Angle, Tin	SAMTEC INC USA	TSW-103-09-T-D-RA
20	2	L1,L2	FIXED IND 8.2mH 100mA 16Ω TH	Wurth Electronics Inc.	744731822
21	1	L3	FIXED IND 3.3µH 4.5A 20 mΩ SMD	Bourns Inc.	SDR0805-3R3ML
22	1	L7	FERRITE BEAD 750Ω 0603 1LN	Laird-Signal Integrity Products	H20603B751R-10
23	1	Q2	MOSFET N-CH 1700V 5.3A Surface Mount D2PAK (7-Lead)	Wolfspeed	C2M1000170J
24	1	R1	RES SMD 10Ω 5% 2/3W 1206	Panasonic Electronic Components	ERJ-P08J100V
25	1	R7	RES SMD 51kΩ 1% 1/10W 0603	Yageo	RC0603FR-0751KL
26	1	R10	RES SMD 14kΩ 1% 1/10W 0603	Panasonic Electronic Components	ERJ-3EKF1402V
27	3	R11,R45,R46	RES SMD 1kΩ 1% 1/4W 0603	Vishay Dale	CRCW06031K00FKEA
28	1	R13	RES SMD 196kΩ 1% 1/10W 0603	Vishay Dale	CRCW0603196KFKEA
29	1	R14	RES SMD 22kΩ 1% 1/10W 0603	Panasonic Electronic Components	ERJ-3EKF2202V
30	1	R37	RES SMD 10Ω 1% 1/8W 0805	Panasonic Electronic Components	ERJ6ENF10R0V
31	2	R38,R39	RES SMD 3.9Ω 1% 1/8W 0805	Vishay Dale	CRCW08053R90FKEA
32	1	R47	RES SMD 17.4kΩ 1% 1/10W 0603	Yageo	RC0603FR-0717K4L
33	1	R48	RES SMD 4.53kΩ 1% 1/10W 0603	Panasonic Electronic Components	ERJ-3EKF4531V
34	1	R49	RES SMD 5.1kΩ 1% 1/10W 0603	Panasonic Electronic Components	ERJ-3EKF5101V
35	2	R50,R54	RES SMD 10kΩ 1% 1/10W 0603	Panasonic Electronic Components	ERJ-3EKF1002V
36	1	R56	RES SMD 0Ω JUMPER 1/4W 0603	Vishay Dale	CRCW06030000Z0EA
37	1	R52	RES SMD 5.1Ω 1% 1/8W 0805	Panasonic Electronic Components	ERJ-6RQF5R1V
38	8	R88,R89,R90,R91,R92,R93,R94, R95	RES SMD 2.2MΩ 1% 1/4W 1206	Vishay Dale	CRCW12062M20FKEA
39	6	R96,R97,R98,R99,R102,R103	RES SMD 232kΩ 1% 1/4W 1206	Panasonic Electronic Components	ERJ-8ENF2323V
40	1	R100	RES SMD 200Ω 1% 3/4W 2010	Vishay Dale	CRCW2010200RFKEF
41	1	R101	RES SMD 2.2Ω 5% 1/3W 1206	Stackpole Electronics Inc.	RPC1206JT2R20
42	1	T1	Flyback Transformer 3.2mH	Kunshan Eagerness Electronics Co., Ltd	PQ20401-802 A
43	1	U1	IC REG CTRLR FLYBK ISO 750IC	Texas Instruments	UCC28740D
44	1	U9	IC VREF SHUNT ADJ SOT23-3	Nexperia USA Inc.	TL431AQDBZ,215
45	1	U11	OPTOISOLATR 5KV TRANSISTOR 4-SOP	Vishay Semiconductor Opto Division	TCLT1003

Table 2: Bill of Materials (BOM) of Cree's CRD15DD17P, 15 W flyback auxiliary power supply board

## 7. Revision History

Date	Revision	Changes
05/01/2018	-	1 <sup>st</sup> Issue

CPWR-AN22, Rev -, 05-2018

Copyright © 2018 Cree, Inc. All rights reserved.

The information in this document is subject to change without notice.

Cree, the Cree logo, and Zero Recovery are registered trademarks of Cree, Inc

## IMPORTANT NOTES

### **Purposes and Use**

Cree, Inc. (on behalf of itself and its affiliates, “Cree”) reserves the right in its sole discretion to make corrections, enhancements, improvements, or other changes to the board or to discontinue the board.

THE BOARD DESCRIBED IS AN ENGINEERING TOOL INTENDED SOLELY FOR LABORATORY USE BY HIGHLY QUALIFIED AND EXPERIENCED ELECTRICAL ENGINEERS TO EVALUATE THE PERFORMANCE OF CREE POWER SWITCHING DEVICES. THE BOARD SHOULD NOT BE USED AS ALL OR PART OF A FINISHED PRODUCT. THIS BOARD IS NOT SUITABLE FOR SALE TO OR USE BY CONSUMERS AND CAN BE HIGHLY DANGEROUS IF NOT USED PROPERLY. THIS BOARD IS NOT DESIGNED OR INTENDED TO BE INCORPORATED INTO ANY OTHER PRODUCT FOR RESALE. THE USER SHOULD CAREFULLY REVIEW THE DOCUMENT TO WHICH THESE NOTIFICATIONS ARE ATTACHED AND OTHER WRITTEN USER DOCUMENTATION THAT MAY BE PROVIDED BY CREE (TOGETHER, THE “DOCUMENTATION”) PRIOR TO USE. USE OF THIS BOARD IS AT THE USER’S SOLE RISK.

### **Operation of Board**

It is important to operate the board within Cree’s recommended specifications and environmental considerations as described in the Documentation. Exceeding specified ratings (such as input and output voltage, current, power, or environmental ranges) may cause property damage. If you have questions about these ratings, please contact Cree at [sic\\_power@cree.com](mailto:sic_power@cree.com) prior to connecting interface electronics (including input power and intended loads). Any loads applied outside of a specified output range may result in adverse consequences, including unintended or inaccurate evaluations or possible permanent damage to the board or its interfaced electronics. Please consult the Documentation prior to connecting any load to the board. If you have any questions about load specifications for the board, please contact Cree at [sic\\_power@cree.com](mailto:sic_power@cree.com) for assistance.

Users should ensure that appropriate safety procedures are followed when working with the board as serious injury, including death by electrocution or serious injury by electrical shock or electrical burns can occur if you do not follow proper safety precautions. It is not necessary in proper operation for the user to touch the board while it is energized. When devices are being attached to the board for testing, the board must be disconnected from the electrical source and any bulk capacitors must be fully discharged. When the board is connected to an electrical source

CPWR-AN22, Rev -, 05-2018

Copyright © 2018 Cree, Inc. All rights reserved.

The information in this document is subject to change without notice.

Cree, the Cree logo, and Zero Recovery are registered trademarks of Cree, Inc.

and for a short time thereafter until board components are fully discharged, some board components will be electrically charged and/or have temperatures greater than 50° Celsius. These components may include bulk capacitors, connectors, linear regulators, switching transistors, heatsinks, resistors and SiC diodes that can be identified using board schematic. Users should contact Cree at [sic\\_power@cree.com](mailto:sic_power@cree.com) for assistance if a board schematic is not included in the Documentation or if users have questions about a board's components. When operating the board, users should be aware that these components will be hot and could electrocute or electrically shock the user. As with all electronic evaluation tools, only qualified personnel knowledgeable in handling electronic performance evaluation, measurement, and diagnostic tools should use the board.

### **User Responsibility for Safe Handling and Compliance with Laws**

Users should read the Documentation and, specifically, the various hazard descriptions and warnings contained in the Documentation, prior to handling the board. The Documentation contains important safety information about voltages and temperatures.

Users assume all responsibility and liability for the proper and safe handling of the board. Users are responsible for complying with all safety laws, rules, and regulations related to the use of the board. Users are responsible for (1) establishing protections and safeguards to ensure that a user's use of the board will not result in any property damage, injury, or death, even if the board should fail to perform as described, intended, or expected, and (2) ensuring the safety of any activities to be conducted by the user or the user's employees, affiliates, contractors, representatives, agents, or designees in the use of the board. User questions regarding the safe usage of the board should be directed to Cree at [sic\\_power@cree.com](mailto:sic_power@cree.com).

In addition, users are responsible for:

- compliance with all international, national, state, and local laws, rules, and regulations that apply to the handling or use of the board by a user or the user's employees, affiliates, contractors, representatives, agents, or designees.
- taking necessary measures, at the user's expense, to correct radio interference if operation of the board causes interference with radio communications. The board may generate, use, and/or radiate radio frequency energy, but it has not been tested for compliance within the limits of computing devices pursuant to Federal Communications Commission or Industry Canada rules, which are designed to provide protection against radio frequency interference.

- compliance with applicable regulatory or safety compliance or certification standards that may normally be associated with other products, such as those established by EU Directive 2011/65/EU of the European Parliament and of the Council on 8 June 2011 about the Restriction of Use of Hazardous Substances (or the RoHS 2 Directive) and EU Directive 2002/96/EC on Waste Electrical and Electronic Equipment (or WEEE). The board is not a finished product and therefore may not meet such standards. Users are also responsible for properly disposing of a board's components and materials.

### **No Warranty**

THE BOARD IS PROVIDED "AS IS" WITHOUT WARRANTY OF ANY KIND, INCLUDING BUT NOT LIMITED TO ANY WARRANTY OF NON-INFRINGEMENT, MERCHANTABILITY, OR FITNESS FOR A PARTICULAR PURPOSE, WHETHER EXPRESS OR IMPLIED. THERE IS NO REPRESENTATION THAT OPERATION OF THIS BOARD WILL BE UNINTERRUPTED OR ERROR FREE.

### **Limitation of Liability**

**IN NO EVENT SHALL CREE BE LIABLE FOR ANY DAMAGES OF ANY KIND ARISING FROM USE OF THE BOARD. CREE'S AGGREGATE LIABILITY IN DAMAGES OR OTHERWISE SHALL IN NO EVENT EXCEED THE AMOUNT, IF ANY, RECEIVED BY CREE IN EXCHANGE FOR THE BOARD. IN NO EVENT SHALL CREE BE LIABLE FOR INCIDENTAL, CONSEQUENTIAL, OR SPECIAL LOSS OR DAMAGES OF ANY KIND, HOWEVER CAUSED, OR ANY PUNITIVE, EXEMPLARY, OR OTHER DAMAGES. NO ACTION, REGARDLESS OF FORM, ARISING OUT OF OR IN ANY WAY CONNECTED WITH ANY BOARD FURNISHED BY CREE MAY BE BROUGHT AGAINST CREE MORE THAN ONE (1) YEAR AFTER THE CAUSE OF ACTION ACCRUED.**

### **Indemnification**

The board is not a standard consumer or commercial product. As a result, any indemnification obligations imposed upon Cree by contract with respect to product safety, product liability, or intellectual property infringement do not apply to the board.