



2N6036
2N6039

COMPLEMENTARY SILICON POWER DARLINGTON TRANSISTORS

- 2N6036 IS A STMicroelectronics PREFERRED SALESTYPE
- COMPLEMENTARY PNP - NPN DEVICES
- INTEGRATED ANTIPARALLEL COLLECTOR-EMITTER DIODE

APPLICATIONS

- GENERAL PURPOSE SWITCHING
- GENERAL PURPOSE AMPLIFIER

DESCRIPTION

The 2N6036 and 2N6039 are complementary silicon power Darlington transistors mounted in Jedec SOT-32 plastic package.

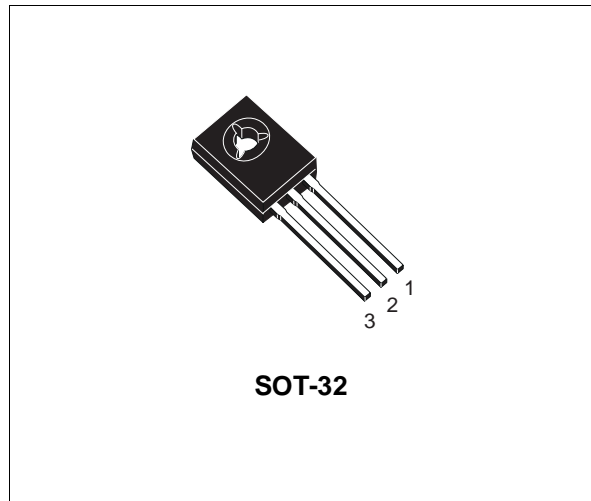

INTERNAL SCHEMATIC DIAGRAM

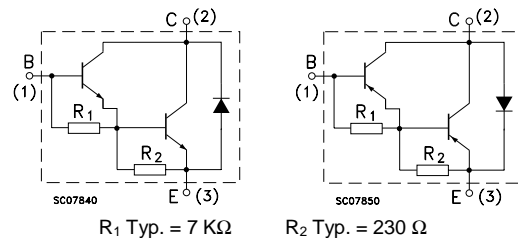

ABSOLUTE MAXIMUM RATINGS

Symbol	Parameter	Value		Unit
		PNP	2N6036	
		NPN	2N6039	
V_{CBO}	Collector-Base Voltage ($I_E = 0$)		80	V
V_{CEO}	Collector-Emitter Voltage ($I_B = 0$)		80	V
V_{EBO}	Emitter-Base Voltage ($I_C = 0$)		5	V
I_C	Collector Current		4	A
I_{CM}	Collector Peak Current		8	A
I_B	Base Current		0.1	A
P_{tot}	Total Dissipation at $T_c \leq 25^\circ\text{C}$		40	W
T_{stg}	Storage Temperature		-65 to 150	$^\circ\text{C}$
T_j	Max. Operating Junction Temperature		150	$^\circ\text{C}$

For PNP types voltage and current values are negative.

THERMAL DATA

R _{thj-case}	Thermal Resistance Junction-case	Max	3.12	°C/W
R _{thj-amb}	Thermal Resistance Junction-ambient	Max	83.3	°C/W

ELECTRICAL CHARACTERISTICS (T_{case} = 25 °C unless otherwise specified)

Symbol	Parameter	Test Conditions	Min.	Typ.	Max.	Unit
I _{CEX}	Collector Cut-off Current (V _{BE} = -1.5V)	V _{CE} = rated V _{CEO} V _{CE} = rated V _{CEO} T _C = 125 °C			0.1 0.5	mA mA
I _{CBO}	Collector Cut-off Current (I _E = 0)	V _{CE} = rated V _{CBO}			0.1	mA
I _{CEO}	Collector Cut-off Current (I _B = 0)	V _{CE} = rated V _{CEO}			0.1	mA
I _{EBO}	Emitter Cut-off Current (I _C = 0)	V _{EB} = 5 V			2	mA
V _{CEO(sus)*}	Collector-Emitter Sustaining Voltage	I _C = 100 mA	80			V
V _{CE(sat)*}	Collector-Emitter Saturation Voltage	I _C = 2 A I _B = 8 mA I _C = 4 A I _B = 40 mA			2 3	V V
V _{BE(sat)*}	Base-Emitter Saturation Voltage	I _C = 4 A I _B = 40 mA			4	V
V _{BE*}	Base-Emitter Voltage	I _C = 2 A V _{CE} = 3 V			2.8	V
h _{FE*}	DC Current Gain	I _C = 0.5 A V _{CE} = 3 V I _C = 2 A V _{CE} = 3 V I _C = 4 A V _{CE} = 3 V	500 750 100		15000	
h _{fe}	Small Signal Current Gain	I _C = 0.75 A V _{CE} = 10 V f = 1KHz	25			
C _{CBO}	Collector Base Capacitance	I _E = 0 V _{CB} = 10 V f = 1MHz for NPN types for PNP types			100 200	pF pF

* Pulsed: Pulse duration = 300 μs, duty cycle 1.5 %

Safe Operating Area

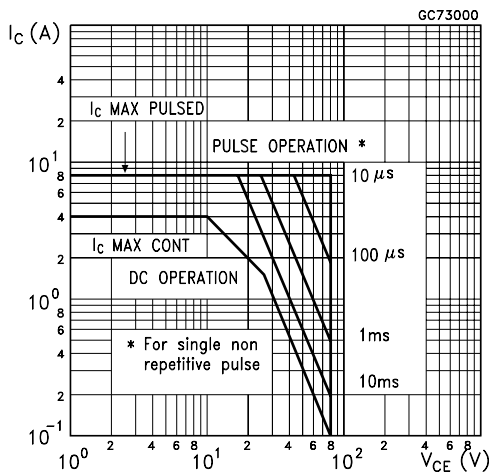

Derating Curve

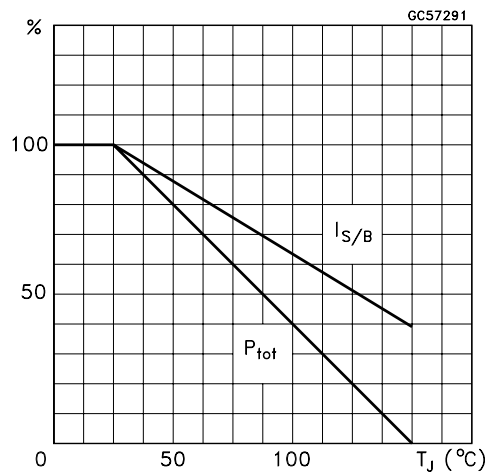

DC Current Gain (NPN type)

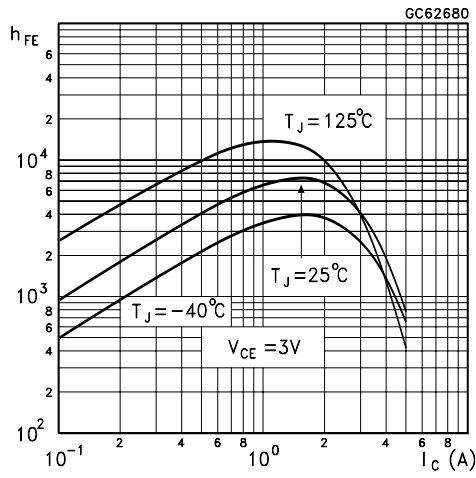

DC Current Gain (PNP type)

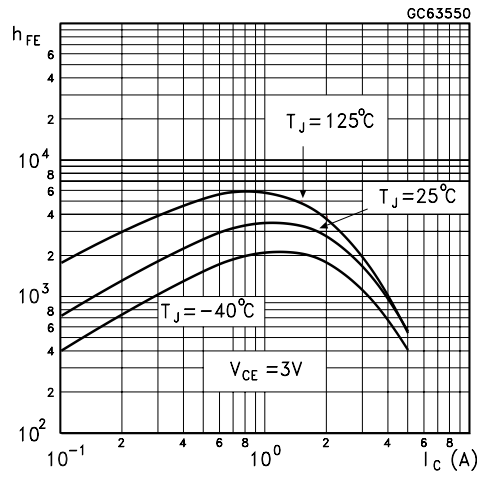

Collector Emitter Saturation Voltage (NPN type)

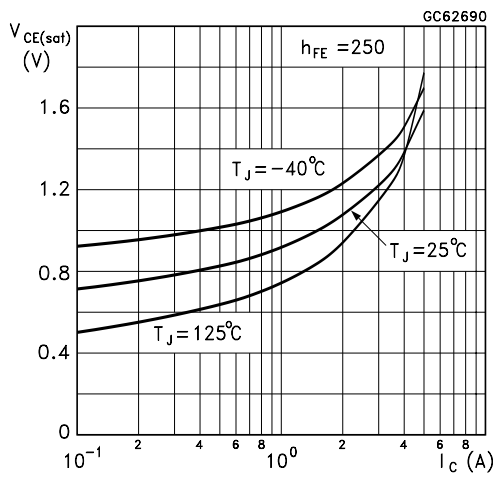

Collector Emitter Saturation Voltage (PNP type)

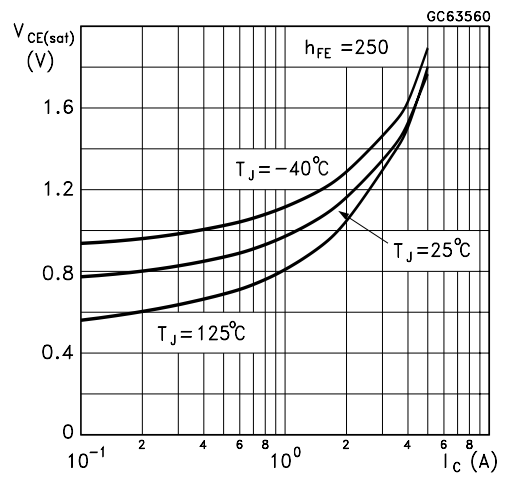

Base Emitter Saturation Voltage (NPN type)

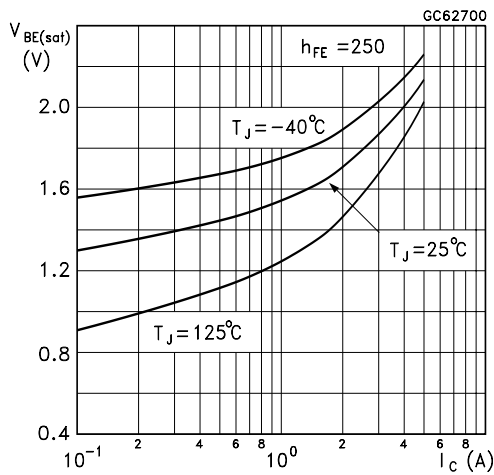

Base Emitter Saturation Voltage (PNP type)

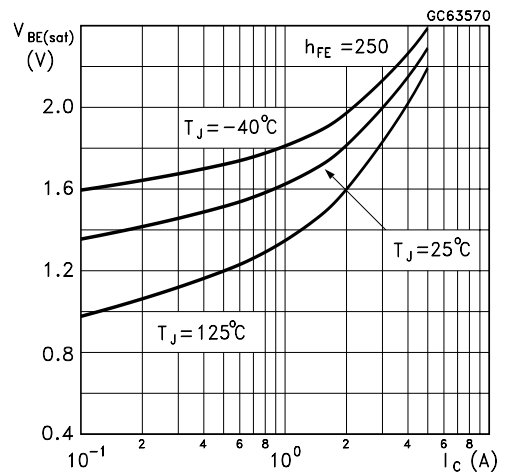

Base-Emitter On Voltage (NPN type)

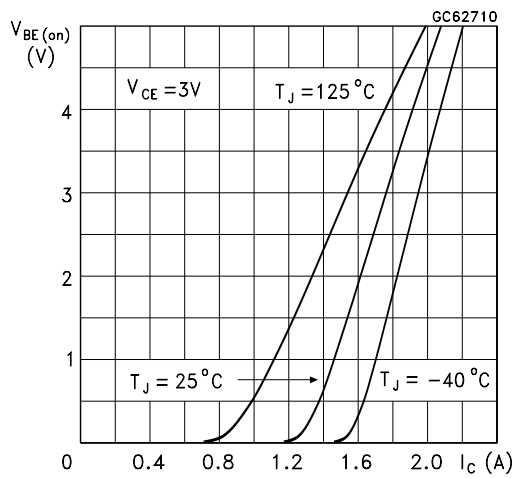

Base-Emitter On Voltage (PNP type)

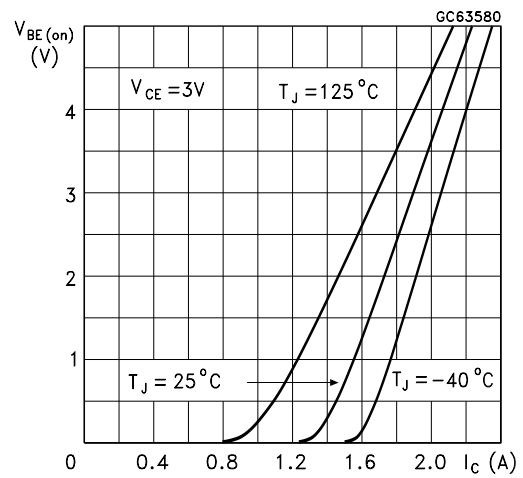

Freewheel Diode Forward Voltage (NPN type)

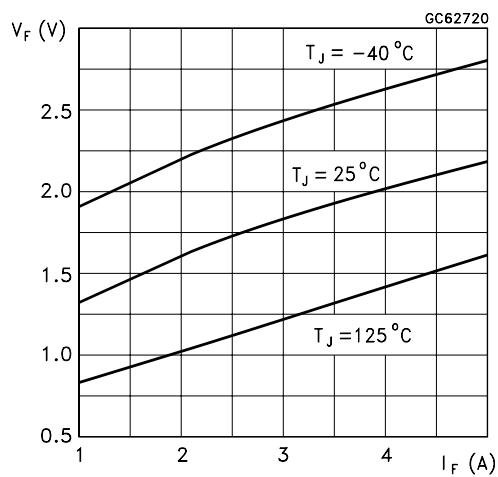

Freewheel Diode Forward Voltage (PNP type)

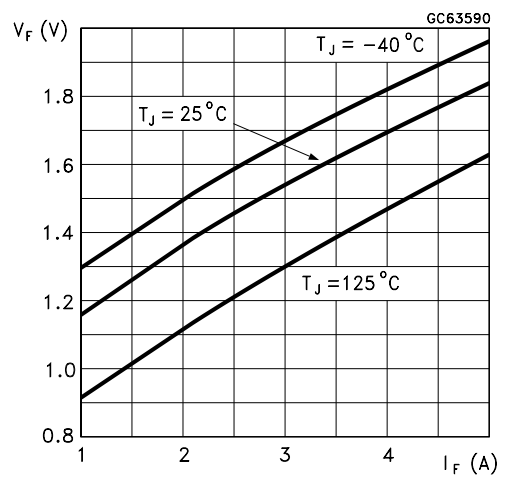

SOT-32 (TO-126) MECHANICAL DATA

DIM.	mm			inch		
	MIN.	TYP.	MAX.	MIN.	TYP.	MAX.
A	7.4		7.8	0.291		0.307
B	10.5		10.8	0.413		0.445
b	0.7		0.9	0.028		0.035
b1	0.49		0.75	0.019		0.030
C	2.4		2.7	0.040		0.106
c1	1.0		1.3	0.039		0.050
D	15.4		16.0	0.606		0.629
e		2.2			0.087	
e3	4.15		4.65	0.163		0.183
F		3.8			0.150	
G	3		3.2	0.118		0.126
H			2.54			0.100

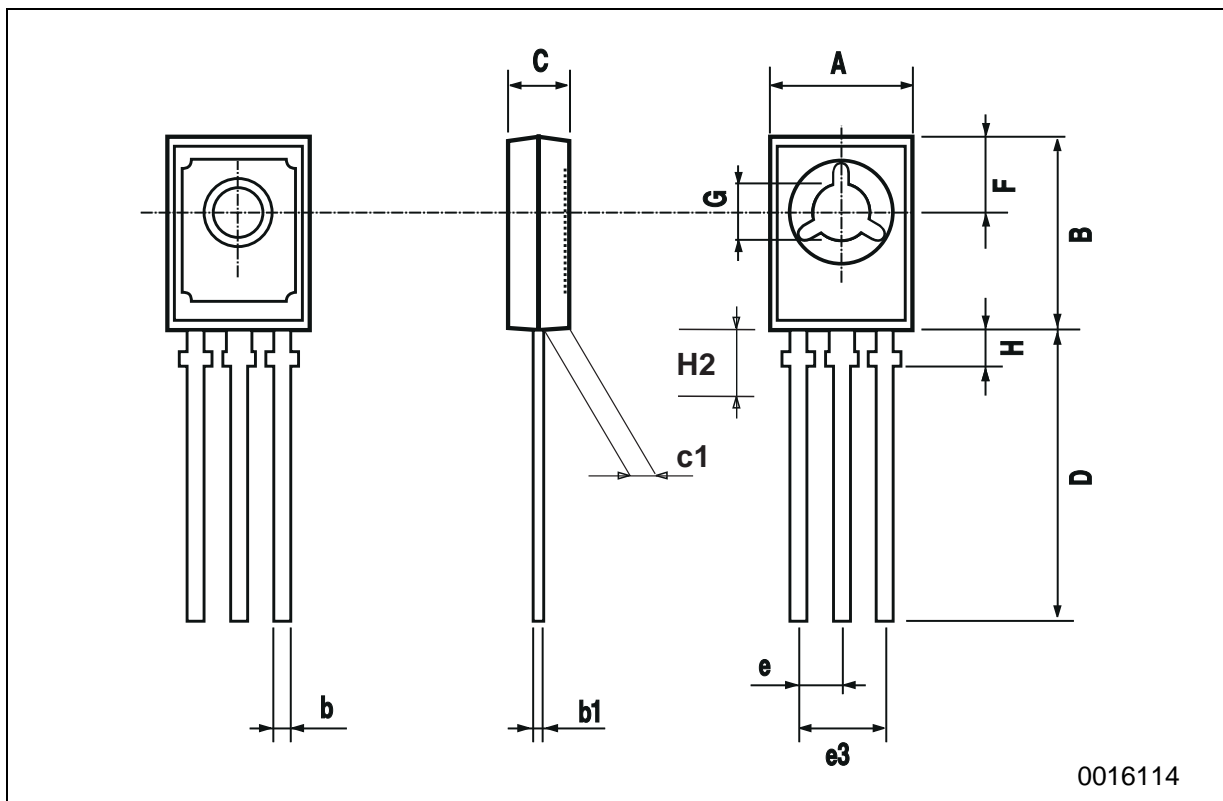

Information furnished is believed to be accurate and reliable. However, STMicroelectronics assumes no responsibility for the consequences of use of such information nor for any infringement of patents or other rights of third parties which may result from its use. No license is granted by implication or otherwise under any patent or patent rights of STMicroelectronics. Specification mentioned in this publication are subject to change without notice. This publication supersedes and replaces all information previously supplied. STMicroelectronics products are not authorized for use as critical components in life support devices or systems without express written approval of STMicroelectronics.

The ST logo is a trademark of STMicroelectronics

© 2000 STMicroelectronics – Printed in Italy – All Rights Reserved

STMicroelectronics GROUP OF COMPANIES

Australia - Brazil - China - Finland - France - Germany - Hong Kong - India - Italy - Japan - Malaysia - Malta - Morocco -
Singapore - Spain - Sweden - Switzerland - United Kingdom - U.S.A.

<http://www.st.com>