



Key Features

- 7-8dB gain
- Small size
- Highly sensitive
- Includes bracket mount
- With or without cable
- Outdoor/indoor

General Description

The Siretta Oscar 20 antenna is a high gain, quad band 4G/3G and 2G antenna.

Ideal for remote telemetry and cellular enabled wireless equipment, Oscar 20 enables global 4G/3G connectivity in remote environments where a point to point link is the only effective method of communication between equipment and single cellsite.

Designed for indoor or outdoor environments and built with ABS plastic, Oscar 20 is supplied with hinged mounting bracket and 5 metres of cable with SMA male termination or alternatively without a cable for you to choose any length and termination of cable you require.

Additional Considerations

- Allows high performance in fringe coverage areas
- 147mm x 170mm (excluding cable)
- SWR rating of 2.0:1
- Multi secured, high mount, ensures simple installation
- Meets all EU compliance criteria for electronic goods
- Can be used with any of our 0 - 20M low loss cable assemblies - SMA male

Key Specifications - Electrical

| | |
|------------------------|------------------------------------|
| Temperature range: | -30 to +70°C |
| Storage temperature: | -40 to +80°C |
| Gain: | 7 - 8dB |
| SWR: | 2.0:1 |
| Operating frequencies: | 850/900/1800/1900/ 2100/2600MHz |
| Polarization: | Vertical |
| Radiating element: | Yagi |

Key Specifications - Mechanical

| | |
|--------------------|--------------------------------------|
| Dimensions: | 170mm x 35mm x 147mm |
| Weight: | 350g (inc. standard cable) |
| Antenna connector: | SMA female |
| Standard antenna: | 5M RG58 cable and SMA male connector |
| Mounting method: | Bracket mount |

Test Reports

Smith Chart

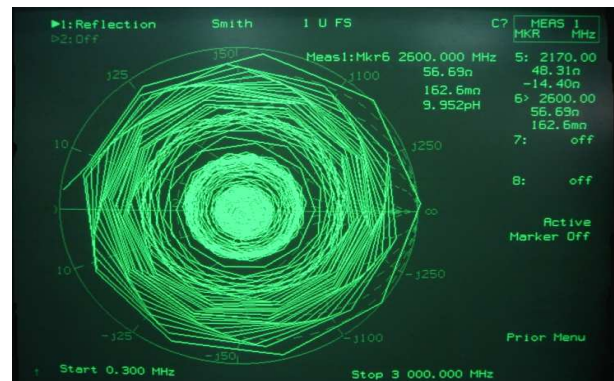
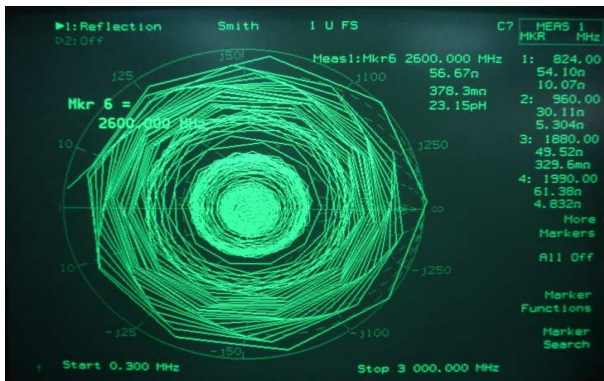

SWR

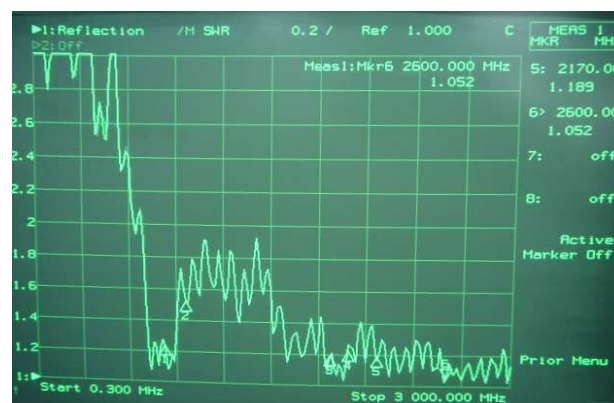
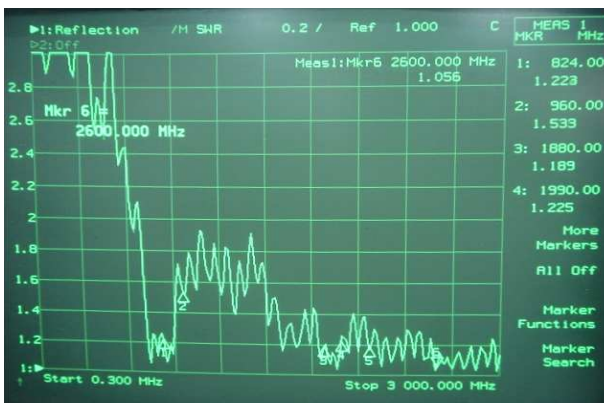

Log Magnitude

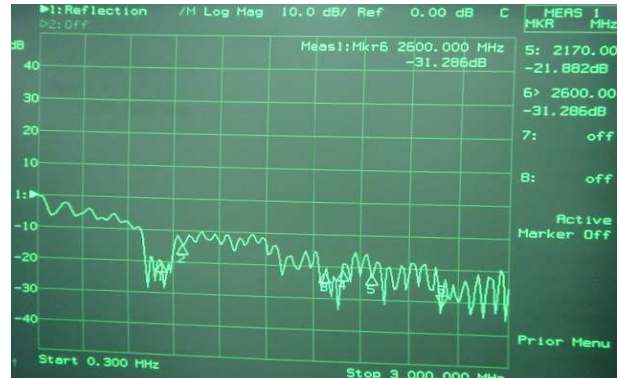
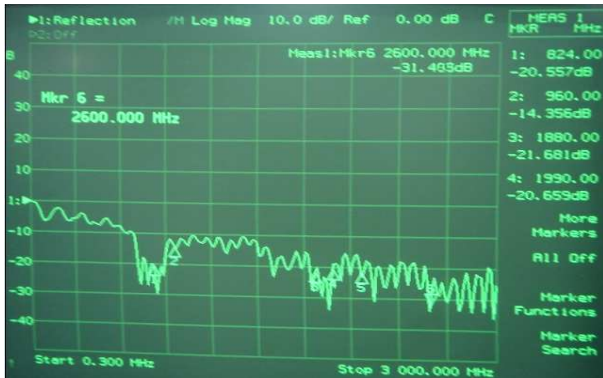

E-Plane Far-field amplitude of 1208-3.nsi

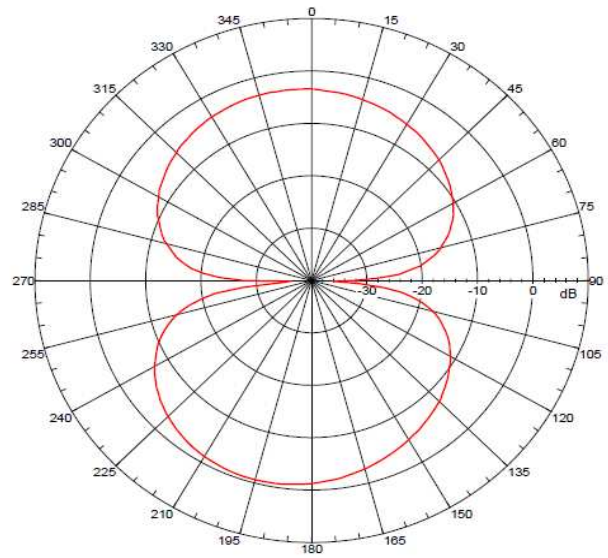
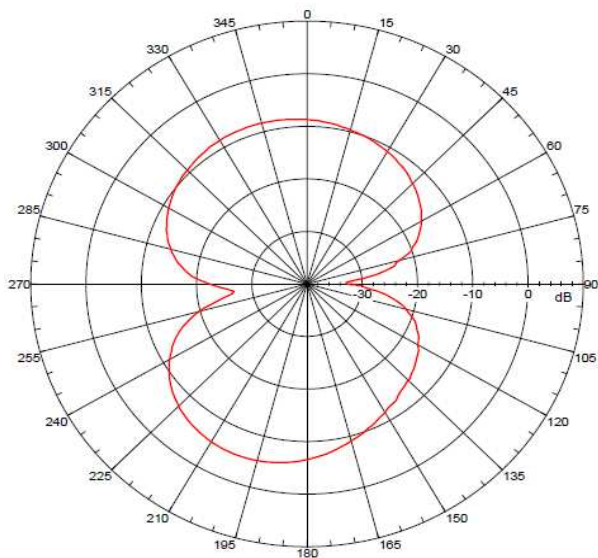

H-Plane
Far-field amplitude of 1208-2.nsi

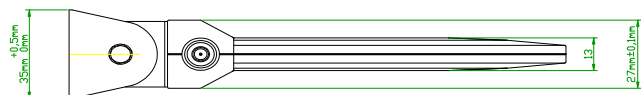
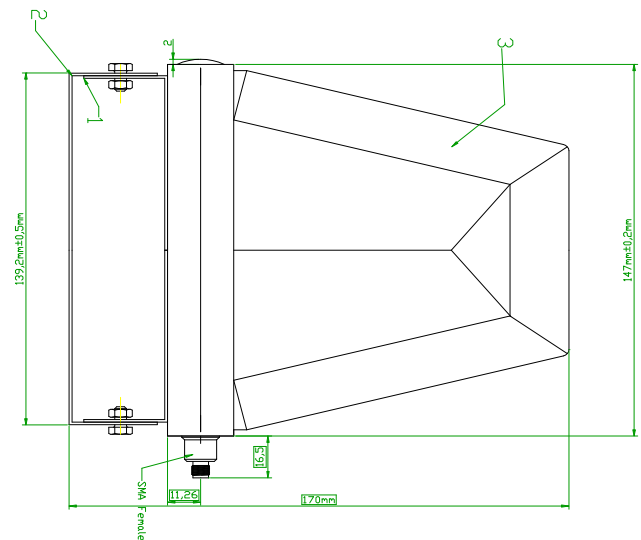
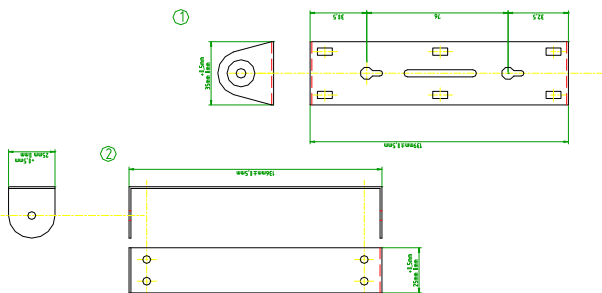
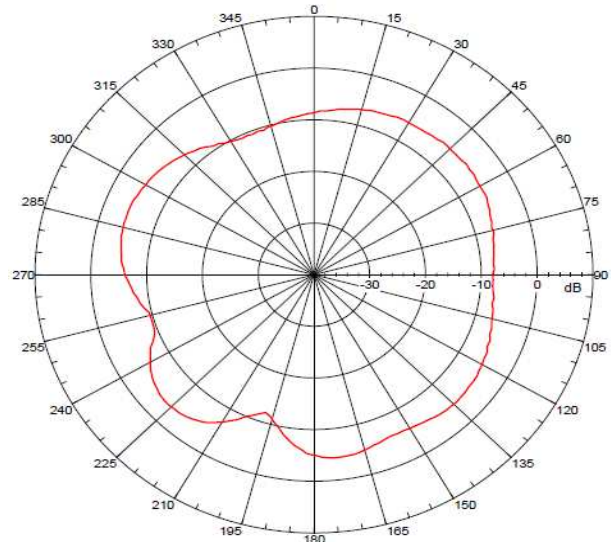
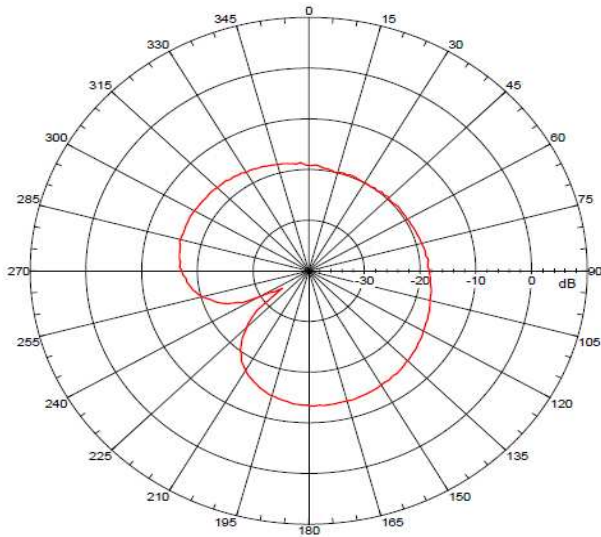

Ordering Details

| Part Number | Description |
|-----------------------|---|
| OSCAR20/X/SMAF/S/S/15 | 4G/3G Antenna, SMA Female Connector |
| OSCAR20/5/SMAM/S/S/16 | 4G/3G Antenna, 5m Cable, SMA Male Connector |