

ARM[®] Cortex[®]-M
32-bit Microcontroller

NuMicro[®] Family
NuTiny-SDK-NUC240
User Manual

The information described in this document is the exclusive intellectual property of Nuvoton Technology Corporation and shall not be reproduced without permission from Nuvoton.

Nuvoton is providing this document only for reference purposes of NuMicro microcontroller based system design. Nuvoton assumes no responsibility for errors or omissions.

All data and specifications are subject to change without notice.

For additional information or questions, please contact: Nuvoton Technology Corporation.

www.nuvoton.com

Table of Contents

1 OVERVIEW 4

2 NUTINY-SDK-NUC240 INTRODUCTION..... 5

 2.1 NuTiny-SDK-NUC240 Jumper Description 6

 2.1.1 Power Setting 6

 2.1.2 Debug Connector 6

 2.1.3 USB Connector 6

 2.1.4 Extended Connector 6

 2.1.5 Reset Button..... 6

 2.1.6 Power Connector 6

 2.1.7 VCOM Enable 6

 2.2 Pin Assignment for Extended Connector 8

 2.3 NuTiny-SDK-NUC240 PCB Placement 10

3 How to Start NuTiny-SDK-NUC240 on the Keil μ Vision[®] IDE 11

 3.1 Keil μ Vision[®] IDE Software Download and Install 11

 3.2 Nuvoton Nu-Link Driver Download and Install 11

 3.3 Hardware Setup..... 11

 3.4 Example Program..... 12

4 How to Start NuTiny-SDK-NUC240 on the IAR Embedded Workbench 13

 4.1 IAR Embedded Workbench Software Download and Install 13

 4.2 Nuvoton Nu-Link Driver Download and Install 13

 4.3 Hardware Setup..... 13

 4.4 Example Program..... 14

5 Starting to Use Nu-Link-Me 3.0 VCOM Function..... 15

 5.1 Downloading and Installing VCOM Driver 15

 5.2 VCOM Mode Setting on NuTiny-SDK-NUC240..... 16

 5.3 Setup on the Development Tool..... 16

 5.3.1 Check the Using UART on the Keil μ Vision[®] IDE..... 16

 5.3.2 Check the Target Device and Debug Setting 16

 5.3.3 Build and Download Code to NuTiny-SDK-NUC240..... 18

 5.3.4 Open the Serial Port Terminal 19

 5.3.5 Reset Chip 19

6 NuTiny-SDK-NUC240 Schematic 21

 6.1 NuTiny-EVB-NUC240 Schematic 21

6.2 GPIO for 100 pin Schematic22

6.3 SDK Circuit Schematic.....23

6.4 Nu-Link-Me V3.0 Schematic24

7 REVISION HISTORY 25

1 OVERVIEW

NuTiny-SDK-NUC240 is the specific development tool for NuMicro® NUC240 series. Users can use NuTiny-SDK-NUC240 to develop and verify the application program easily.

NuTiny-SDK-NUC240 includes two portions. One is NuTiny-EVB-NUC240 and the other is Nu-Link-Me. NuTiny-EVB-NUC240 is the evaluation board and Nu-Link-Me is its Debug Adaptor. Thus, users do not need other additional ICE or debug equipments.

2 NUTINY-SDK-NUC240 INTRODUCTION

NuTiny-SDK-NUC240 uses the NUC240VE3AE as the target microcontroller. Figure 2-1 is NuTiny-SDK-NUC240 for NUC240 series, the left portion is called NuTiny-EVB-NUC240 and the right portion is Debug Adaptor called Nu-Link-Me.

NuTiny-EVB-NUC240 is similar to other development boards. Users can use it to develop and verify applications to emulate the real behavior. The on board chip covers NUC240 series features. The NuTiny-EVB-NUC240 can be a real system controller to design users' target systems.

Nu-Link-Me is a Debug Adaptor. The Nu-Link-Me Debug Adaptor connects your PC's USB port to your target system (via Serial Wired Debug Port) and allows you to program and debug embedded programs on the target hardware. The Nu-Link-Me V3.0 also supports VCOM function, which gives users more flexibility when debug. To use Nu-Link-Me Debug adaptor with IAR or Keil, please refer to "Nuvoton NuMicro® IAR ICE driver user manual" or Nuvoton NuMicro® Keil ICE driver user manual" in detail. These two documents will be stored in the local hard disk when the user installs each driver. To use Nu-Link-Me 3.0 VCOM function, please refer to Chapter 5.

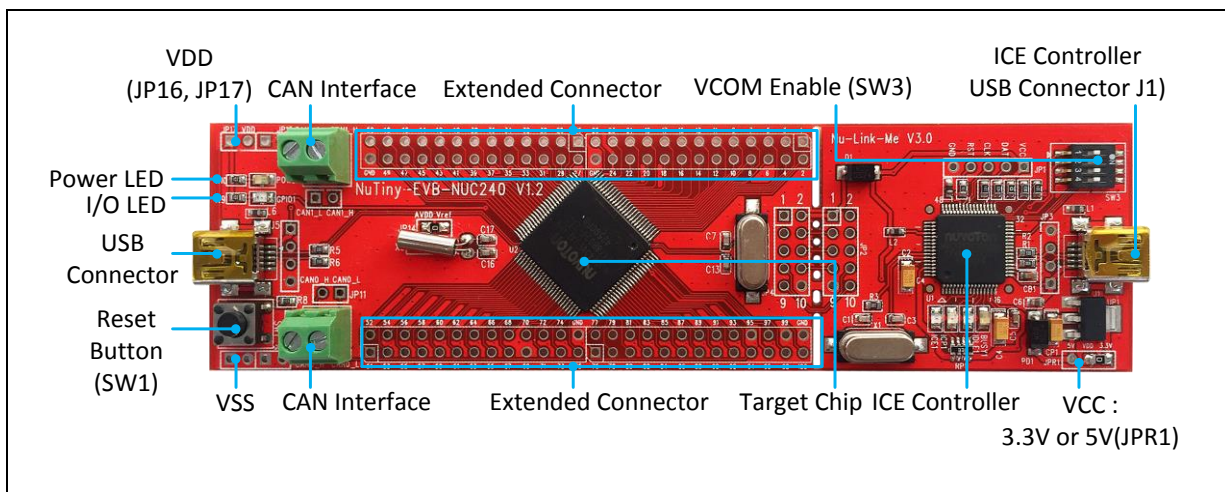

Figure 2-1 NuTiny-SDK-NUC240 (PCB Board)

2.1 NuTiny-SDK-NUC240 Jumper Description

2.1.1 Power Setting

- J5: USB port in NuTiny-EVB-NUC240
- JP17: VCC5 Voltage connector in NuTiny-EVB-NUC240
- J1: USB port in Nu-Link-Me
- JPR1: Select 5V or 3V for system power

Model	JPR1	J1 USB port	J2 VDD	MCU Voltage
Model 1	Connect to PC	X	DC 5V output	DC 5V
Model 2	X	Connect to PC	DC 5V output	DC 5V
Model 3	X	X	DC 2.5-5.5V input	Voltage by VCC input

X: Unused.

2.1.2 Debug Connector

- JP4: Connector in target board (NuTiny-EVB-NUC240) for connecting with Nuvoton ICE adaptor (Nu-Link-Me)
- JP2: Connector in ICE adaptor (Nu-Link-Me) for connecting with a target board (for example NuTiny-EVB-NUC240)

2.1.3 USB Connector

- J5: Mini USB Connector in NuTiny-EVB-NUC240 for application use
- J1: Mini USB Connector in Nu-Link-Me connected to a PC USB port

2.1.4 Extended Connector

- Show all chip pins in NuTiny-EVB-NUC240

2.1.5 Reset Button

- SW1: Reset button in NuTiny-EVB-NUC240

2.1.6 Power Connector

- JP17: VDD connector in NuTiny-EVB-NUC240
- JP2: VSS connector in NuTiny-EVB-NUC240

2.1.7 VCOM Enable

- **SW3**: VCOM function enable for NuTiny-SDK-NUC240. Switch SW3 on before power on to enable VCOM function. SW3 connects pin 32(PB.0/RXD) and pin 33(PB.1/TXD) in NuTiny-EVB-NUC240 with pin 22(PB.1/TXD) and pin 21(PB.0/RXD) in Nuvoton ICE adaptor (Nu-Link-Me V3.0). SW3 connects pin 30(VCOM) in Nuvoton ICE adaptor (Nu-Link-Me V3.0) to GND to enable VCOM function.

Switch Pin Number	Function Name	UART0 Mode	VCOM Mode
1	ICE_TX	Off	On
2	ICE_RX	Off	On
3	VCOM_EN	Off	On
4	X	X	X

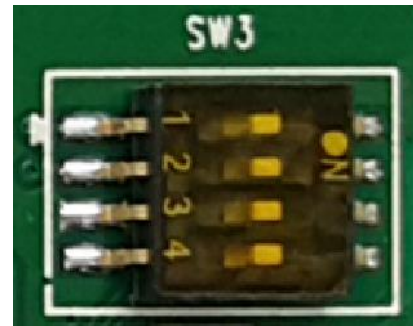

X: Unused.

2.2 Pin Assignment for Extended Connector

NuTiny-EVB-NUC240 provides NUC240VE3AE on board and the extended connector for LQFP100-pin. Table 2-1 is the pin assignment for NUC240VE3AE.

Pin No	Pin Name	Pin No	Pin Name
01	PE.15	51	PE.4
02	PE.14	52	PE.3
03	PE.13	53	PE.2
04	PB.14/INT0/SPI3_SS1/AD0	54	PE.1/PWM7
05	PB.13/ACMP1_O/AD1	55	PE.0/PWM6
06	VBAT	56	PC.13/SPI1_MOSI1
07	X32_OUT	57	PC.12/SPI1_MISO1
08	X32_IN	58	PC.11/SPI1_MOSI0
09	PA.11/I2C1_SCL/CAN1_RXD/nRD	59	PC.10/SPI1_MISO0
10	PA.10/I2C1_SDA/CAN1_TXD/nWR	60	PC.9/SPI1_CLK
11	PA.9/I2C0_SCL	61	PC.8/SPI1_SS0/MCLK
12	PA.8/I2C0_SDA	62	PA.15/PWM3/I2S_MCLK/SC2_PWR
13	PD.8/SPI3_SS0	63	PA.14/PWM2/SC2_RST/AD15
14	PD.9/SPI3_CLK	64	PA.13/PWM1/SC2_CLK/UART5_TXD/AD14
15	PD.10/SPI3_MISO0	65	PA.12/PWM0/SC2_DAT/UART5_RXD/AD13
16	PD.11/SPI3_MOSI0	66	ICE_DAT
17	PD.12/SPI3_MISO1	67	ICE_CLK
18	PD.13/SPI3_MOSI1	68	VDD
19	PB.4/UART1_RXD	69	VSS
20	PB.5/UART1_TXD	70	AVSS
21	PB.6/UART1_nRTS/ALE	71	PA.0/ADC0/SC0_PWR
22	PB.7/UART1_nCTS/nCS	72	PA.1/ADC1/SC0_RST/AD12
23	LDO_CAP	73	PA.2/ADC2/SC0_CLK/UART3_TXD/AD11
24	VDD	74	PA.3/ADC3/SC0_DAT/UART3_RXD/AD10
25	VSS	75	PA.4/ADC4/SC1_PWR/AD9
26	PE.8	76	PA.5/ADC5/SC1_RST/AD8

27	PE.7	77	PA.6/ADC6/SC1_CLK/UART4_TXD/AD7
28	VBUS	78	PA.7/ADC7/SPI2_SS1/SC1_DAT/UART4_RXD/AD6
29	USB_VBUS	79	Vref
30	USB_VDD33_CAP	80	AVDD
31	USB_D-	81	PD.0/SPI2_SS0
32	USB_D+	82	PD.1/SPI2_CLK
33	PB.0/UART0_RXD	83	PD.2/SPI2_MISO0
34	PB.1/UART0_TXD	84	PD.3/SPI2_MOSI0
35	PB.2/UART0_nRTS/TM2_EXT/ACMP0_O/TM2/nWRL	85	PD.4/SPI2_MISO1
36	PB.3/UART0_nCTS/TM3_EXT/SC2_CD/TM3/nWRH	86	PD.5/SPI2_MOSI1
37	PD.6/CAN0_RXD	87	PC.7/ACMP0_N/SC1_CD/AD5
38	PD.7/CAN0_TXD	88	PC.6/ACMP0_P/SC0_CD/AD4
39	PD.14/UART2_RXD/CAN1_RXD	89	PC.15/ACMP1_N/AD3
40	PD.15/UART2_TXD/CAN1_TXD	90	PC.14/ACMP1_P/AD2
41	PC.5/SPI0_MOSI1	91	PB.15/INT1/TM0/TM0_EXT/AD6
42	PC.4/SPI0_MISO1	92	XT1_OUT/PF.0
43	PC.3/SPI0_MOSI0/I2S_DO	93	XT1_IN/PF.1
44	PC.2/SPI0_MISO0/I2S_DI	94	nRESET
45	PC.1/SPI0_CLK/I2S_BCLK	95	VSS
46	PC.0/SPI0_SS0/I2S_LRCLK	96	VDD
47	PE.6	97	PF.2/PS2_DAT
48	PE.5/PWM5/TM1/TM1_EXT	98	PF.3/PS2_CLK
49	PB.11/TM3/PWM4	99	PVSS
50	PB.10/TM2/SPI0_SS1	100	PB.8/TM0/STADC/CLKO

Table 2-1 Pin Assignment for NUC240

3 HOW TO START NUTINY-SDK-NUC240 ON THE KEIL MVISION® IDE

3.1 Keil uVision® IDE Software Download and Install

Please visit the Keil company website (<http://www.keil.com>) to download the Keil μ Vision® IDE and install the RVMDK

3.2 Nuvoton Nu-Link Driver Download and Install

Please visit the Nuvoton company NuMicro® website (<http://www.nuvoton.com/NuMicro>) to download “NuMicro® Keil μ Vision® IDE driver” file. When the Nu-Link driver has been well downloaded, please unzip the file and execute the “Nu-Link_Keil_Driver.exe” to install the driver.

3.3 Hardware Setup

The hardware setup is shown as Figure 3-1.



Figure 3-1 NuTiny-SDK-NUC240 Hardware Setup

3.4 Example Program

This example demonstrates the ease of downloading and debugging an application on a NuTiny-SDK-NUC240 board. It can be found on Figure 3-2 list directory and downloaded from Nuvoton NuMicro® website.







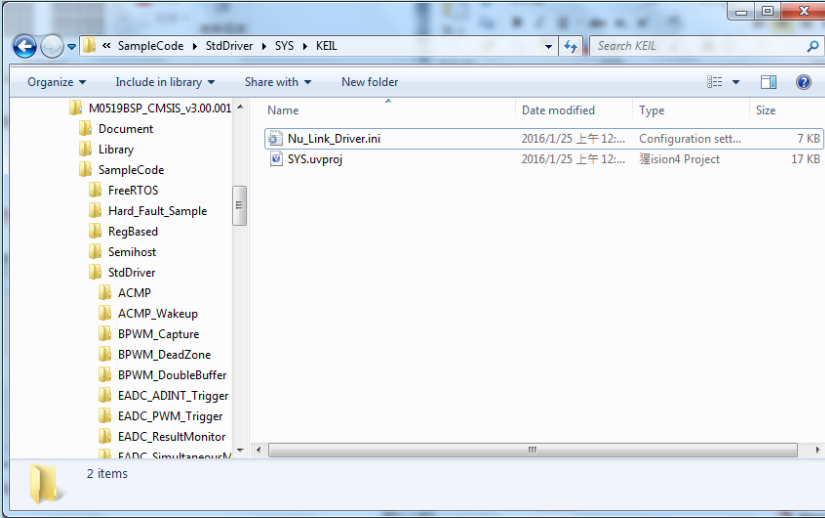

<p>Directory</p>	<p>C:\Nuvoton\BSP Library\ NUC230_240_Series_BSP_CMSIS_V3.01.00 \SampleCode\StdDriver\SYS\KEIL</p>
<p>Project File</p>	

Figure 3-2 Example Directory

To use this example:

This sample code will show some functions about system manager controller and clock controller.

-  **Start µVision®**
- **Project-Open**
Open the SYS.uvproj project file
-  **Project - Build**
Compile and link the SYS application
-  **Flash – Download**
Program the application code into on-chip Flash ROM
-  **Start debug mode**
Using the debugger commands, you may:
 - ◆  Review variables in the watch window
 - ◆  Single step through code
 - ◆  Reset the device
 - ◆  Run the application

4 HOW TO START NUTINY-SDK-NUC240 ON THE IAR EMBEDDED WORKBENCH

4.1 IAR Embedded Workbench Software Download and Install

Please connect to IAR company website (<http://www.iar.com>) to download the IAR Embedded Workbench and install the EWARM.

4.2 Nuvoton Nu-Link Driver Download and Install

Please visit the Nuvoton company NuMicro® website (<http://www.nuvoton.com/NuMicro>) to download the “NuMicro® IAR EWARM Driver” file. When the Nu-Link driver has been well downloaded, please unzip the file and execute the “Nu-Link_Keil_Driver.exe” to install the driver.

4.3 Hardware Setup

The hardware setup is shown as Figure 4-1.

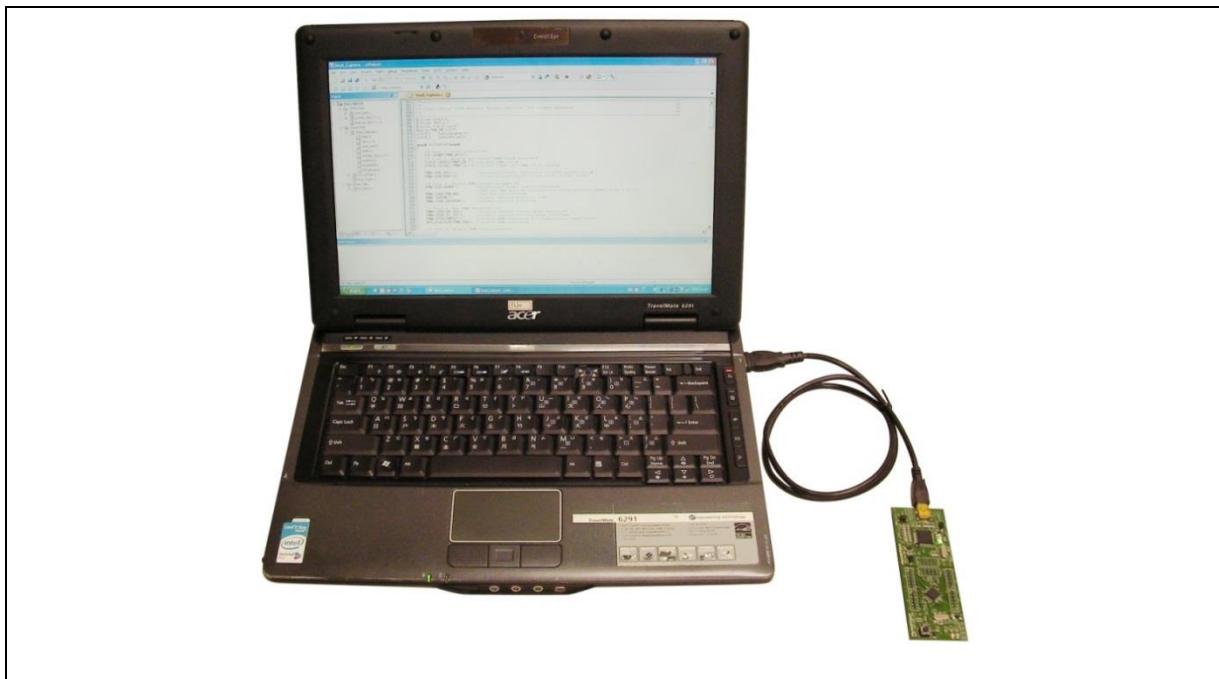

Figure 4-1 NuTiny-SDK-NUC240 Hardware Setup







4.4 Example Program

This example demonstrates the ease of downloading and debugging an application on a NuTiny-SDK-NUC240 board. It can be found on Figure 4-2 list directory and downloaded from Nuvoton NuMicro® website.

Directory	<p>C:\Nuvoton\BSP Library \NUC230_240_Series_BSP_CMSIS_V3.01.001 \SampleCode\StdDriver\SYS\IAR</p>
Project File	

Figure 4-2 Example Directory

This sample code will show some functions about system manager controller and clock controller.

-  Start IAR Embedded Workbench
-  Project – Download and Debug Program the application code into on-chip Flash ROM
- File-Open-Workspace
Open the SYS.eww workspace file
-  Single step through code
-  Reset the device
-  Project - Make
Compile and link the SYS application
-  Run the application

5 STARTING TO USE NU-LINK-ME 3.0 VCOM FUNCTION

5.1 Downloading and Installing VCOM Driver

Please connect to Nuvoton NuMicro® website (<http://www.nuvoton.com/NuMicro>) to download the “NuMicro® ICP Programming Tool” file. After the ICP Programming Tool driver is downloaded, please unzip the file and execute the “ICP Programming Tool.exe”. Simply follow the installation and optional steps to install ICP Programming Tool and Nu-Link USB Driver, which included VCOM driver.

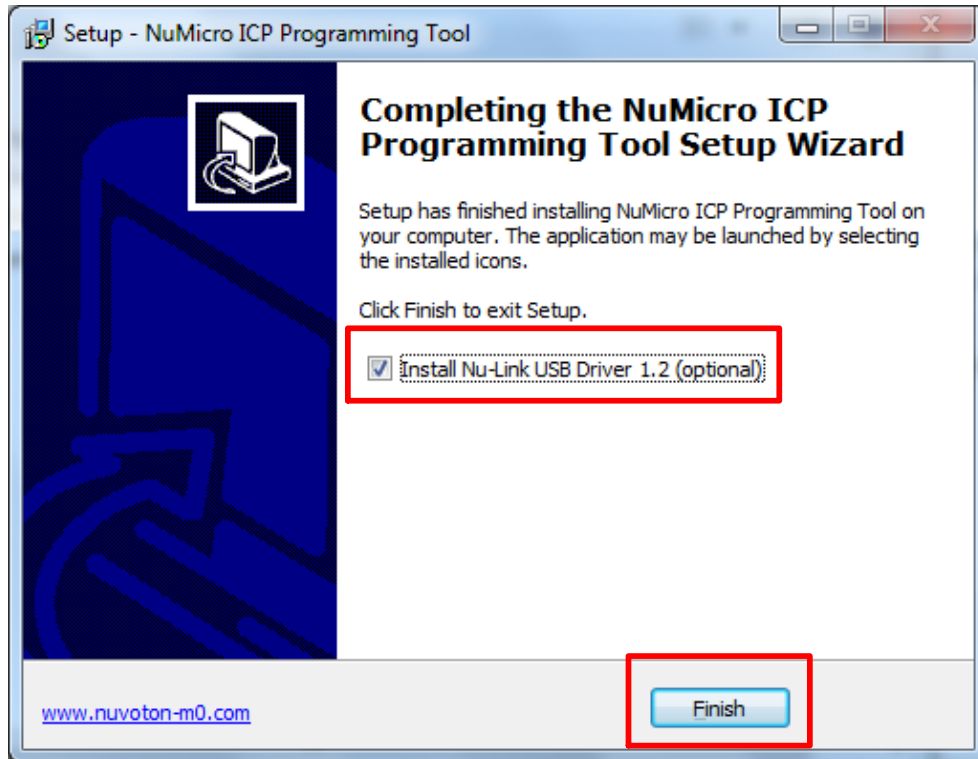

Figure 5-1 Optional Step after ICP Programming Tool Installation

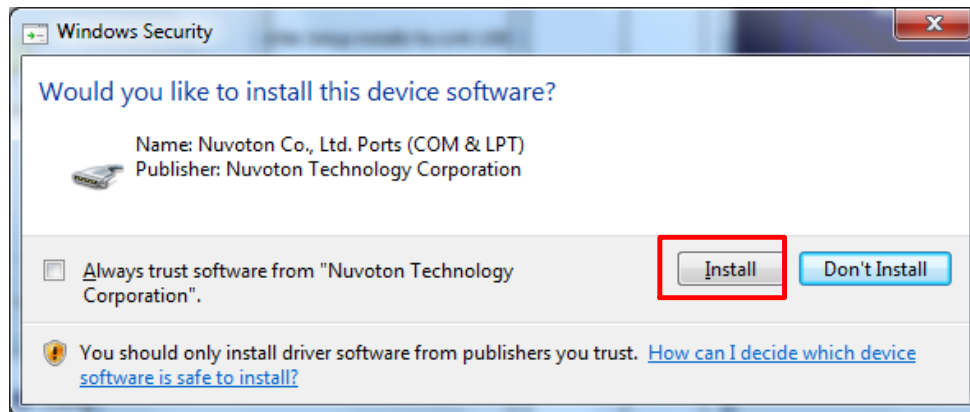

Figure 5-2 Install Nuvoton COM&LPT Driver

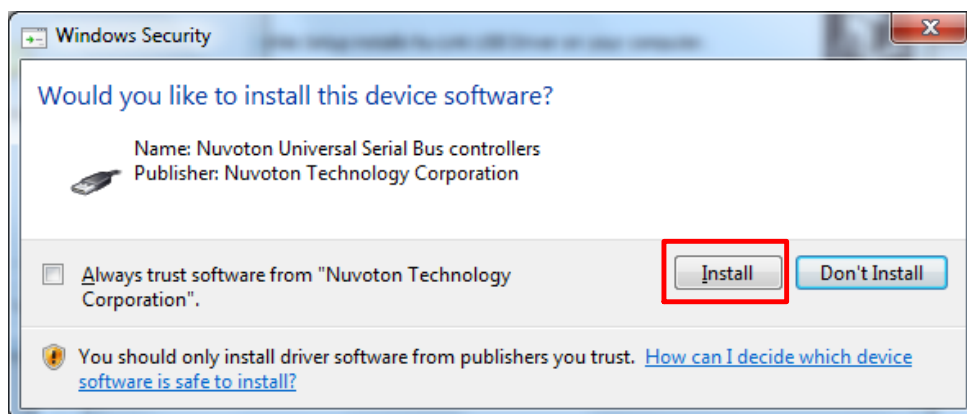

Figure 5-3 Install Nuvoton Universal Serial Bus Controllers

5.2 VCOM Mode Setting on NuTiny-SDK-NUC240

Before the NuTiny-SDK-NUC240 is connected to the PC, please enable SW3 VCOM function by switching on SW3. The NuTiny-EVB-NUC240 transmits through UART0 to VCOM to send out data. Switch SW3 off when using UART0 function without VCOM function.

5.3 Setup on the Development Tool

The example is demonstrated on the Keil μ Vision[®] IDE.

5.3.1 Check the Using UART on the Keil μ Vision[®] IDE

Please open the project and find system_NUC240.h to check the using UART in DEBUG_PORT, which has to be the same as the using UART in the NuTiny-EVB-NUC240.

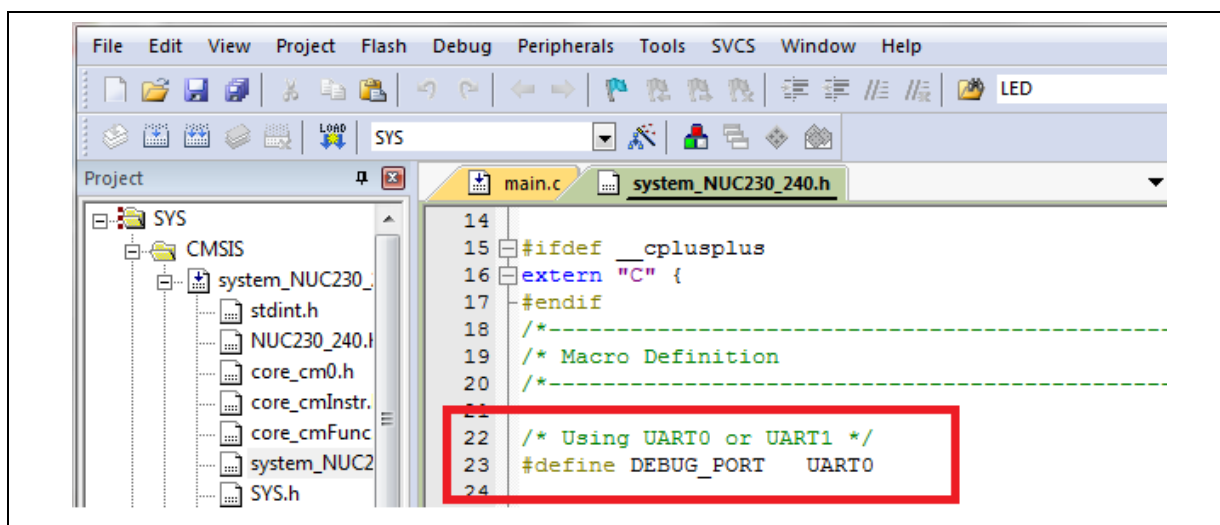
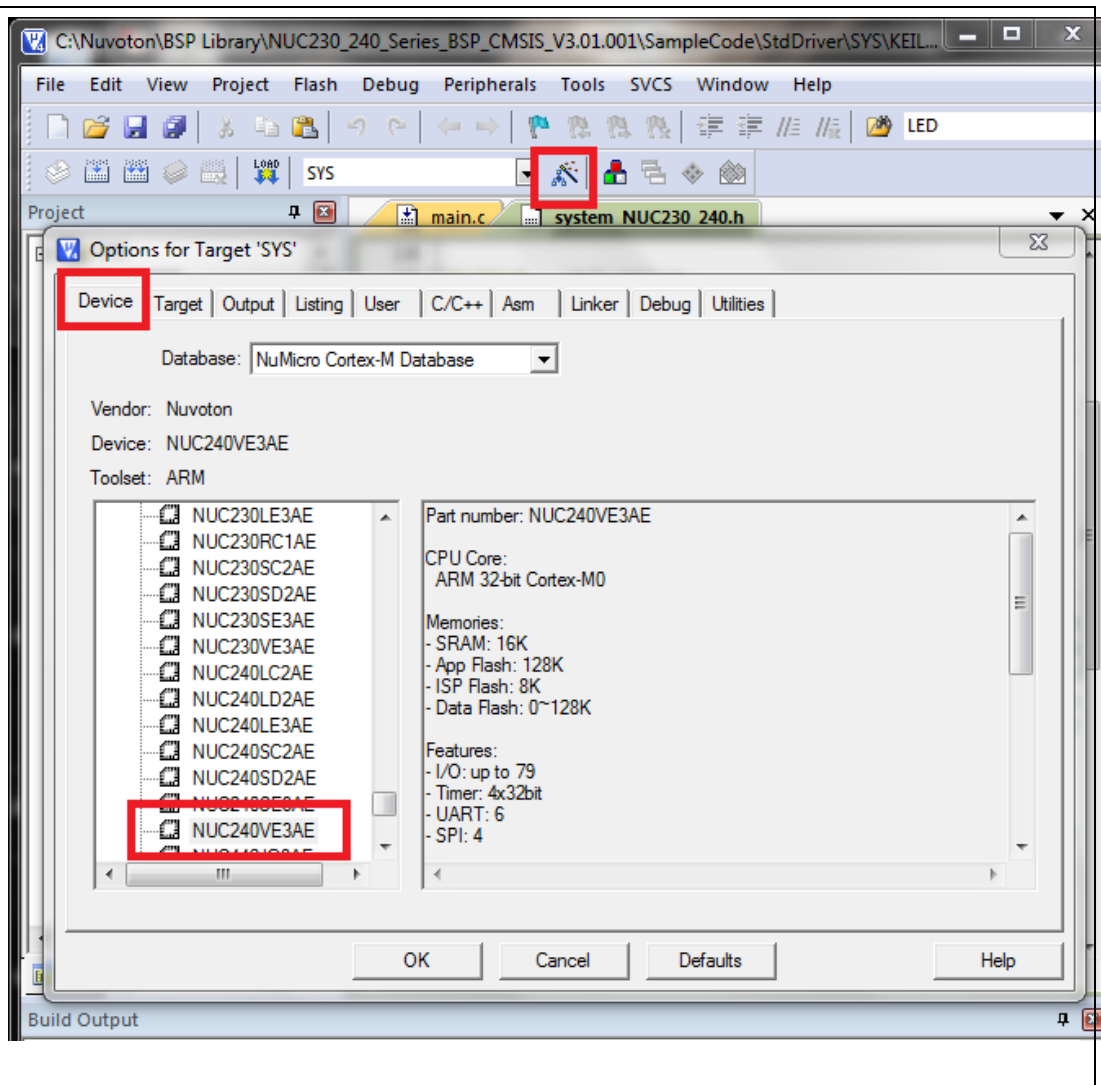

Figure 5-4 The Using UART on Keil μ Vision[®] IDE

5.3.2 Check the Target Device and Debug Setting

The target device has to be the same as the setting in Debug. Please click "Target Option" to open the Option windows, and find the setting in "Device", "Debug", and "Utilities" page. Please follow the steps below to check the setting.

Step 1



Step 2

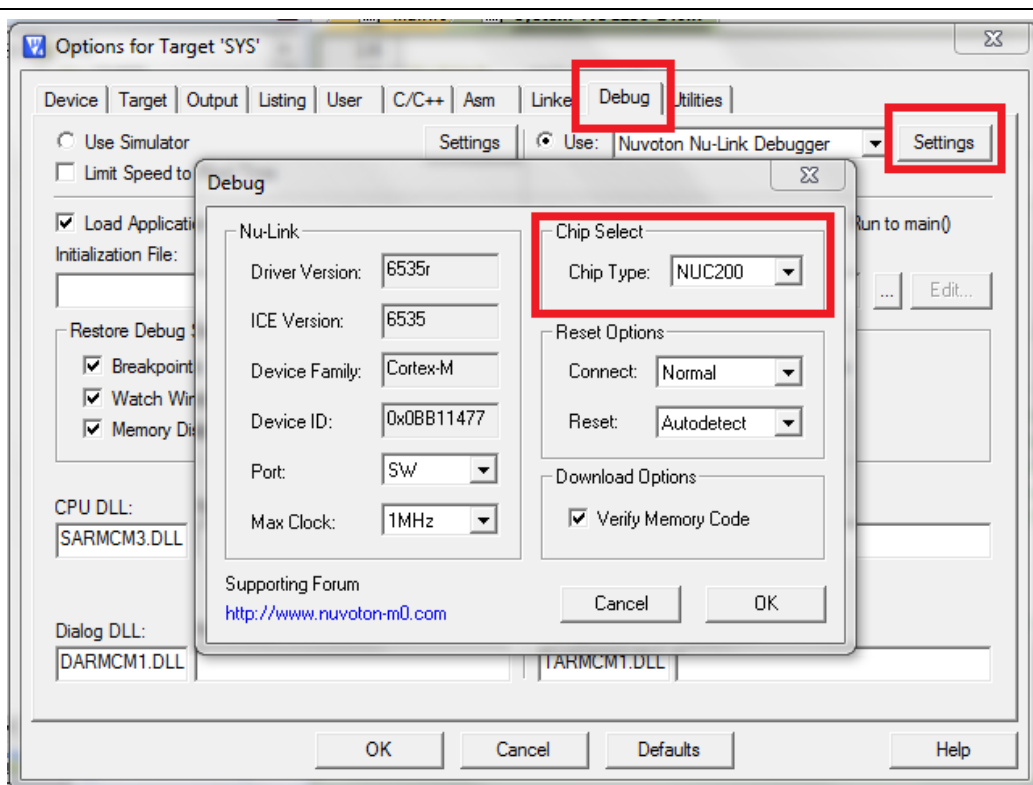

Step 3

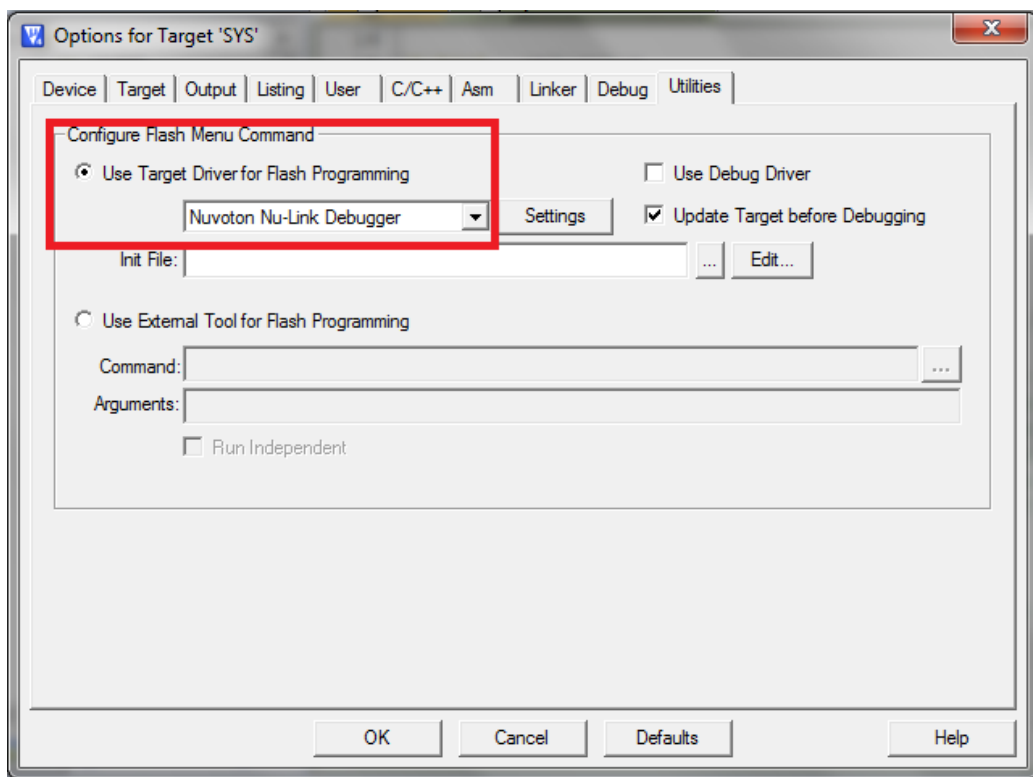

5.3.3 Build and Download Code to NuTiny-SDK-NUC240

Please build the project and download code to NuTiny-SDK-NUC240.

5.3.4 Open the Serial Port Terminal

User can use serial port terminal, PuTTY for example, to print out debug message.

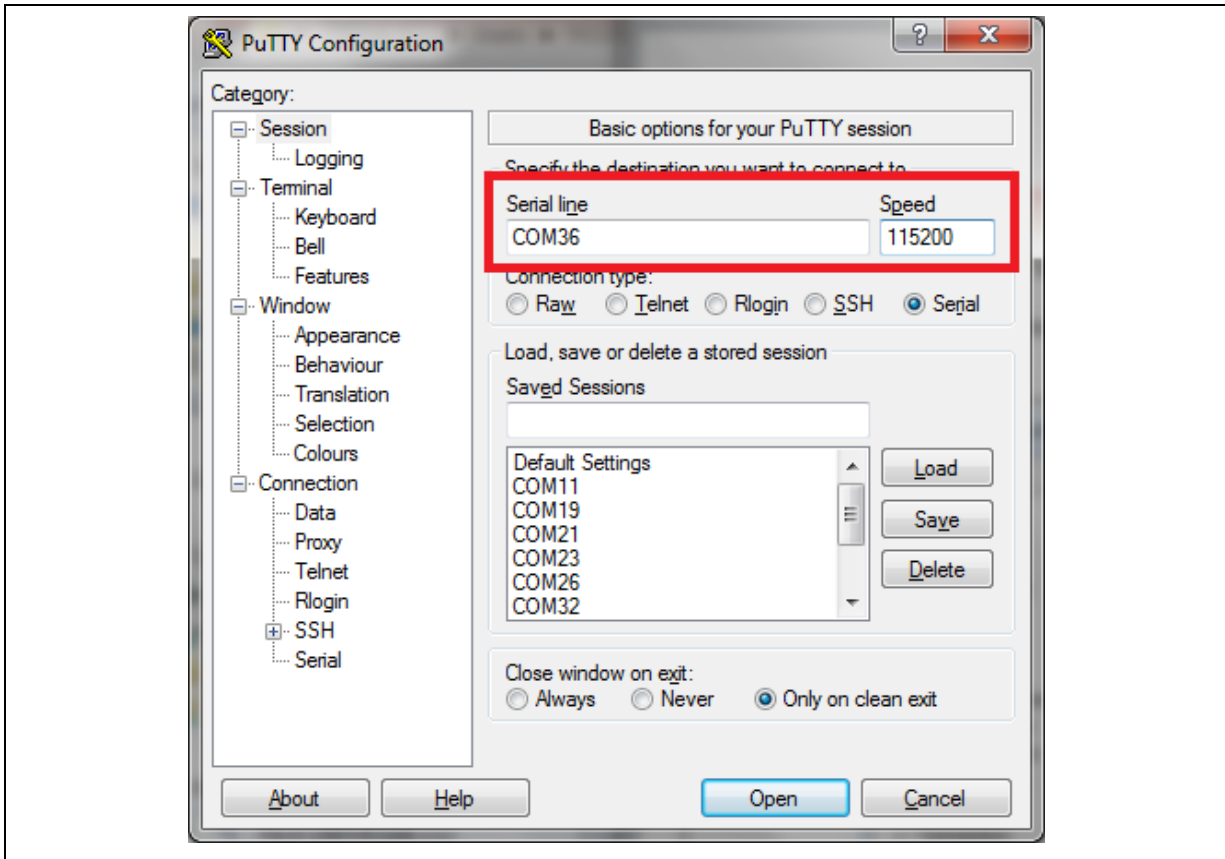

Figure 5-5 Set Baud Rate

5.3.5 Reset Chip

After pushing the reset button, the chip will reprogram application and print out debug message.

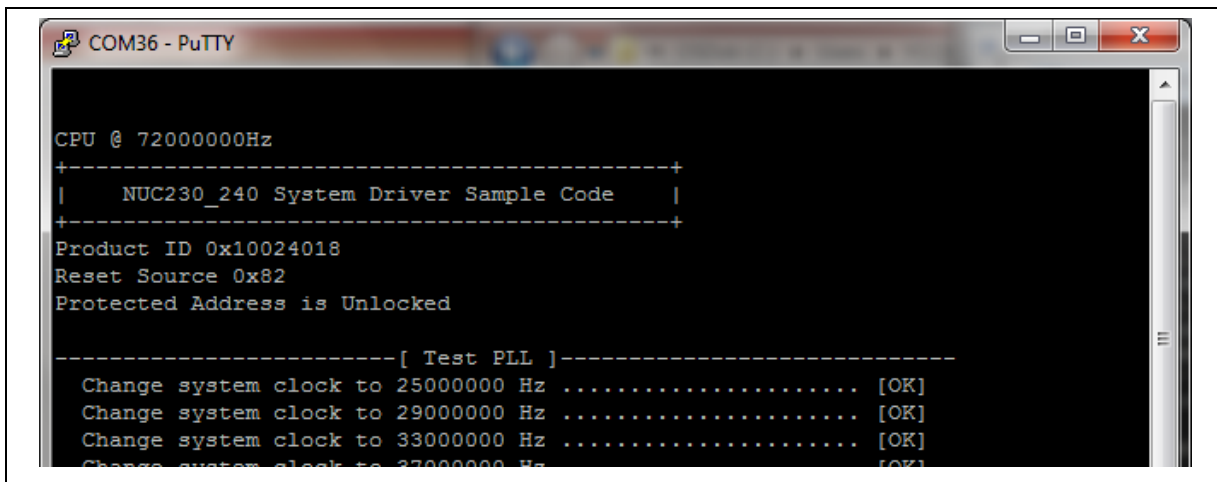
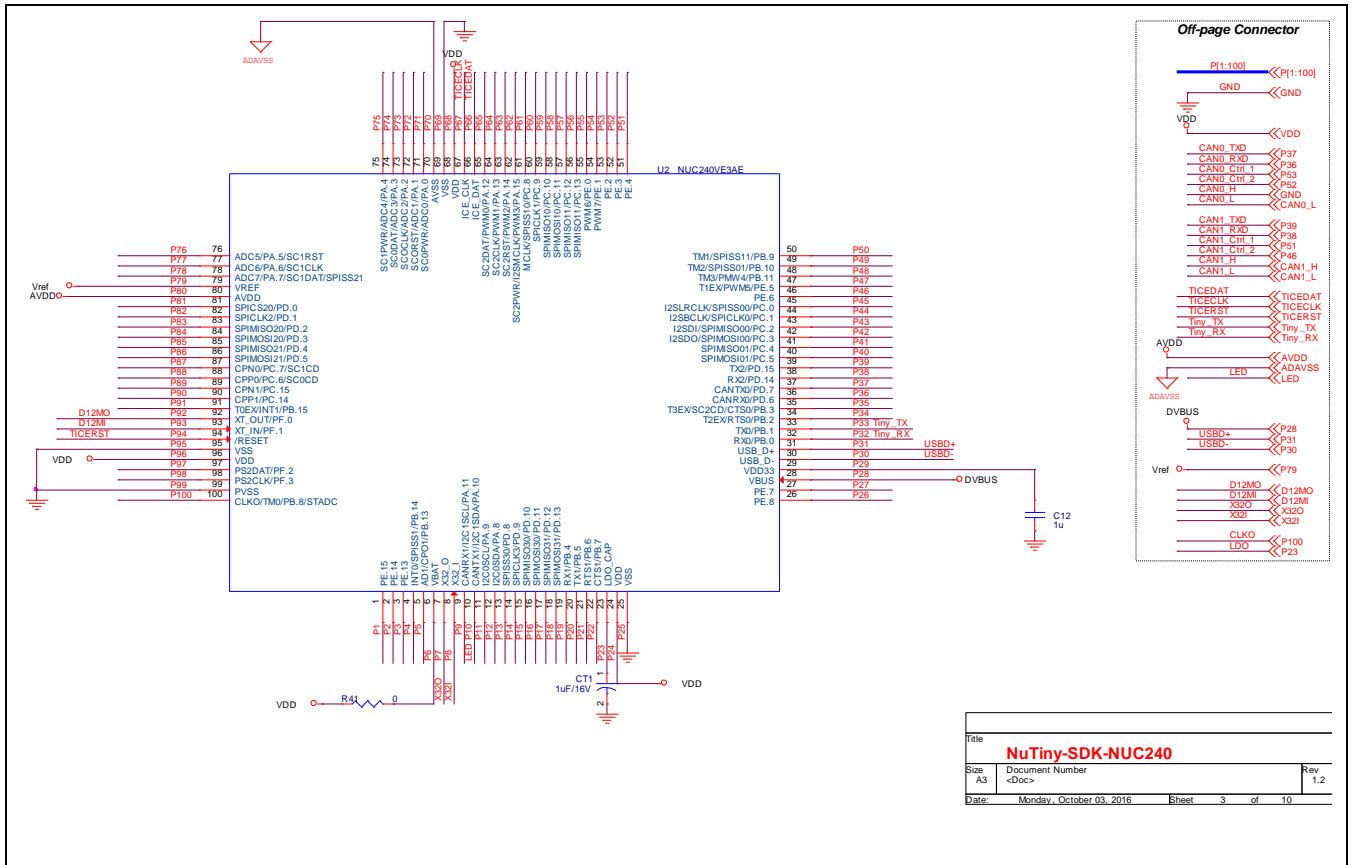

Figure 5-6 Serial Port Terminal Windows

Notice: Please switch SW3 on before the NuTiny-SDK-NUC240 connects to the PC. When the NuTiny-SDK-NUC240 connects to the PC with SW3 switch on, PC will detect VCOM as a USB device and the detection will only be processed once. VCOM will not function if switch on SW3 after the connection.

6 NUTINY-SDK-NUC240 SCHEMATIC

6.1 NuTiny-EVB-NUC240 Schematic



6.2 GPIO for 100 pin Schematic

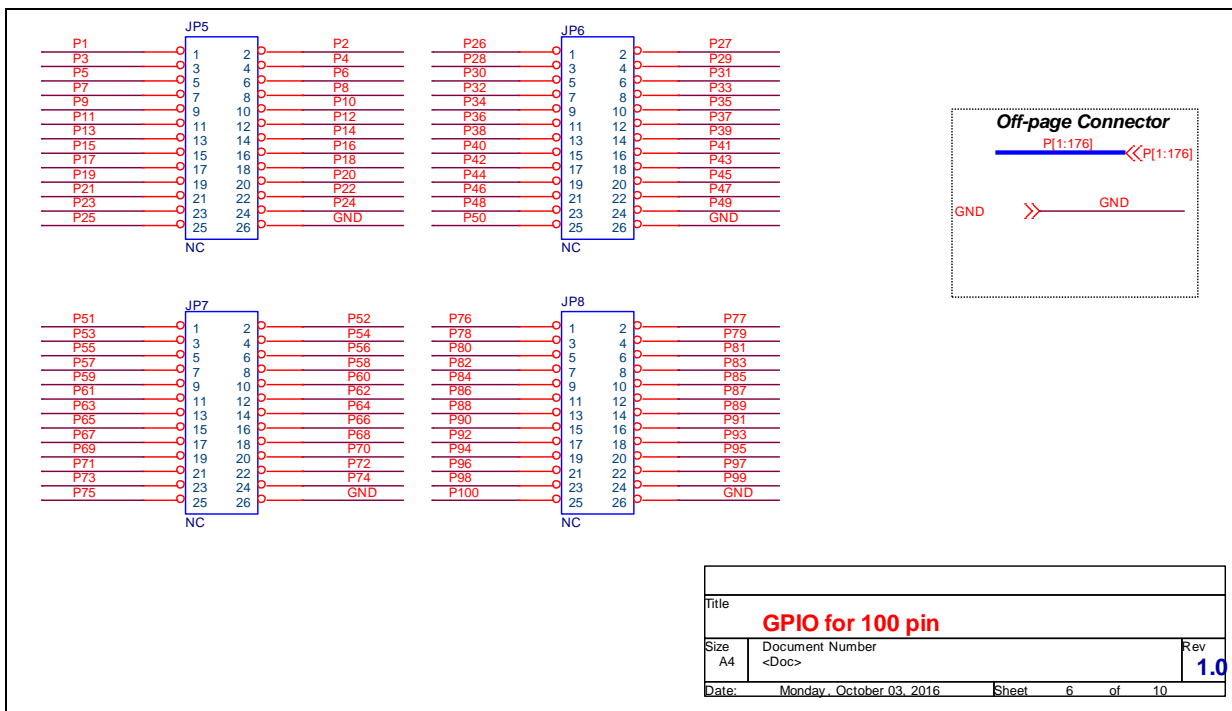

6.3 SDK Circuit Schematic

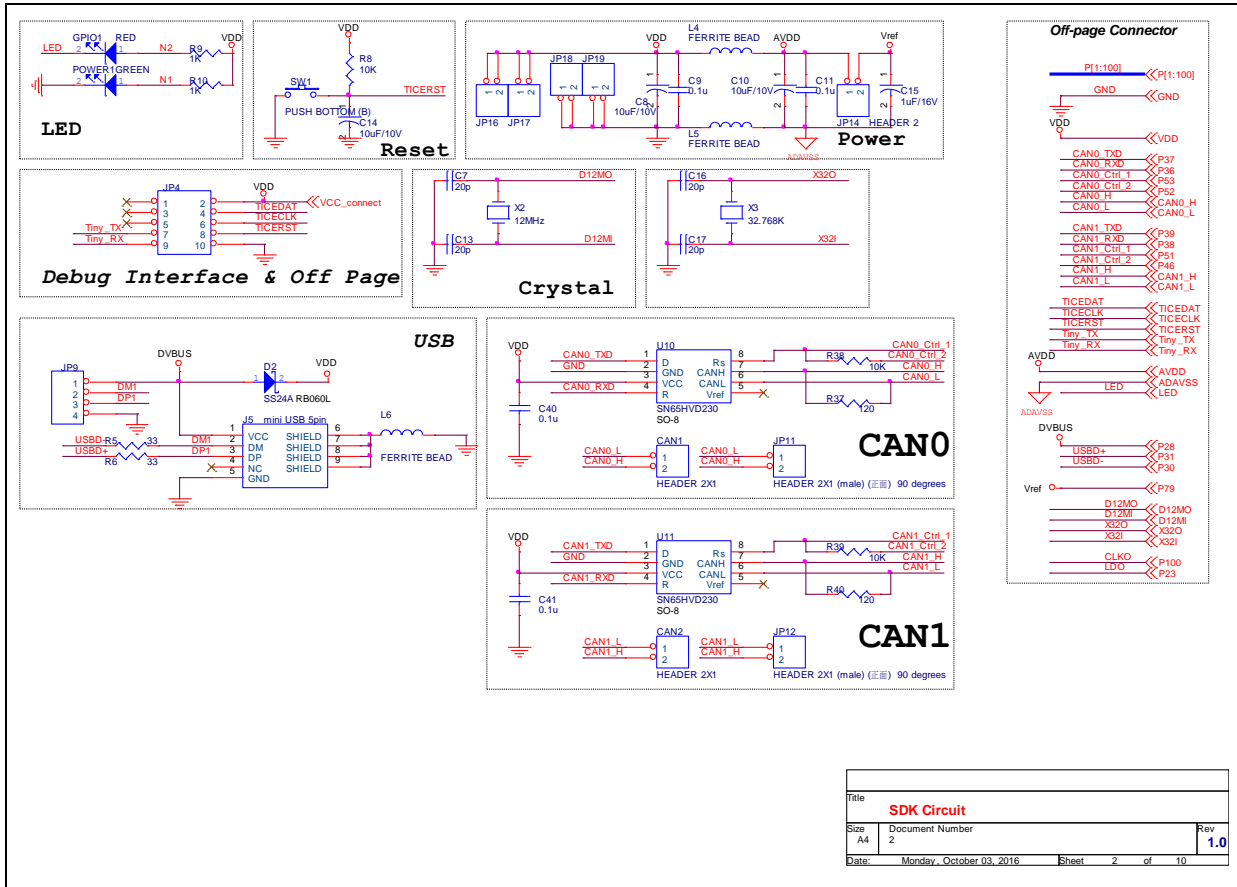

6.4 Nu-Link-Me V3.0 Schematic

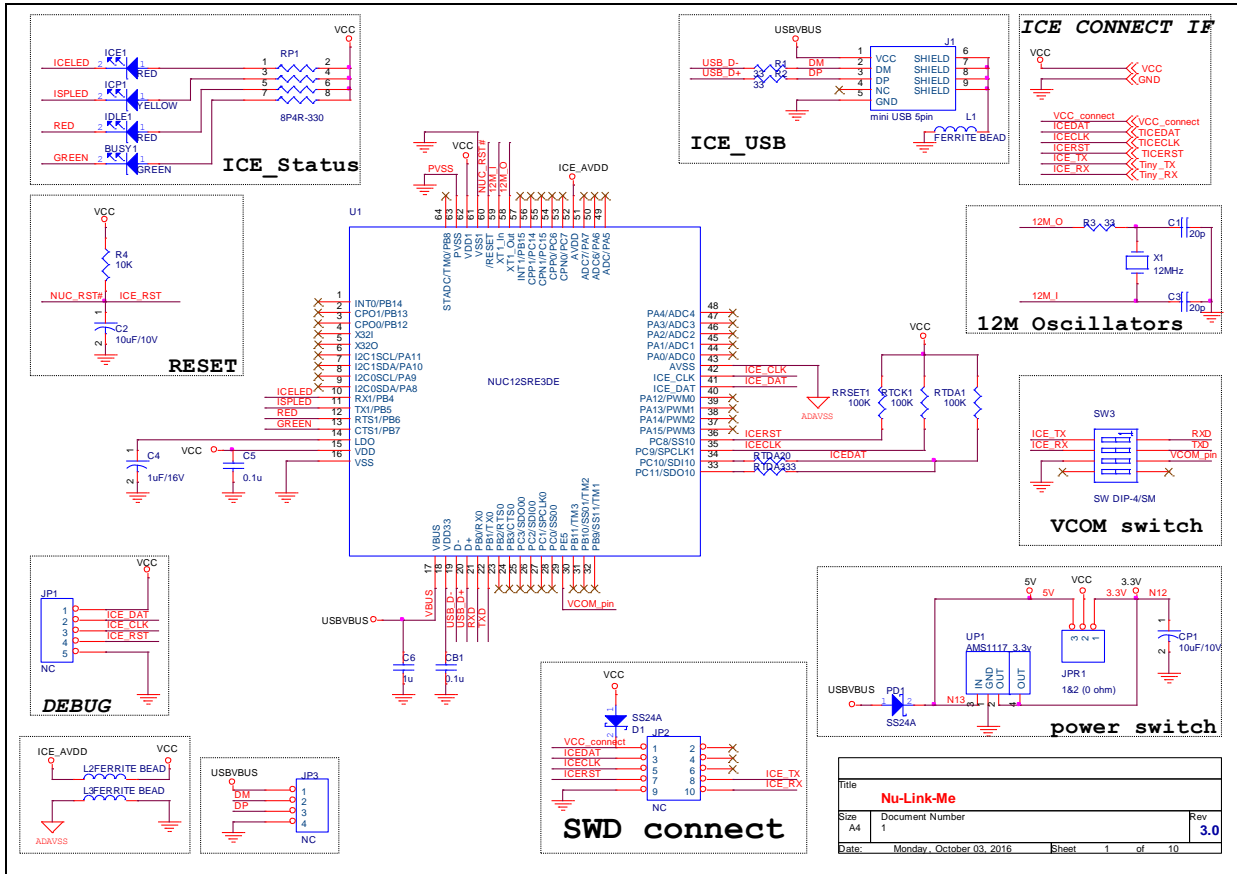

7 REVISION HISTORY

Date	Revision	Description
2012.09.14	1.00	1. Initially issued.
2016.10.03	1.10	<ol style="list-style-type: none"> 1. Updated the figure of NuTiny-SDK-NUC240 PCB Board in section 2. 2. Updated the Jumper descriptions of NuTiny-SDK-NUC240 in section 2.1. 3. Updated the figure of NuTiny-SDK-NUC240 PCB Placement in section 2.3. 4. Updated the descriptions of example program in section 3.4 and section 4.4. 5. Added the descriptions of Nu-Link Me V3.0 in section 2 and section 5. 6. Updated the schematics of NuTiny-SDK-NUC240 in section 6.

Important Notice

Nuvoton Products are neither intended nor warranted for usage in systems or equipment, any malfunction or failure of which may cause loss of human life, bodily injury or severe property damage. Such applications are deemed, "Insecure Usage".

Insecure usage includes, but is not limited to: equipment for surgical implementation, atomic energy control instruments, airplane or spaceship instruments, the control or operation of dynamic, brake or safety systems designed for vehicular use, traffic signal instruments, all types of safety devices, and other applications intended to support or sustain life.

All Insecure Usage shall be made at customer's risk, and in the event that third parties lay claims to Nuvoton as a result of customer's Insecure Usage, customer shall indemnify the damages and liabilities thus incurred by Nuvoton.

*Please note that all data and specifications are subject to change without notice.
All the trademarks of products and companies mentioned in this datasheet belong to their respective owners.*