

Surface Mount ESD Capability Rectifiers

eSMP® Series

DO-220AA (SMP)

 AUTOMOTIVE
GRADE

RoHS
COMPLIANT
HALOGEN
FREE

FEATURES

- Very low profile - typical height of 1.0 mm
- Ideal for automated placement
- Oxide planar chip junction
- Low forward voltage drop
- Typical I_R less than 0.1 μ A
- ESD capability
- Meets MSL level 1, per J-STD-020, LF maximum peak of 260 °C
- AEC-Q101 qualified
- Material categorization: for definitions of compliance please see www.vishay.com/doc?99912

MECHANICAL DATA

Case: DO-220AA (SMP)

 Molding compound meets UL 94 V-0 flammability rating
Base P/N-M3 - halogen-free, RoHS-compliant, and commercial grade

Base P/NHM3 - halogen-free, RoHS-compliant, and automotive grade

Terminals: Matte tin plated leads, solderable per J-STD-002 and JESD 22-B102

M3 suffix meets JESD 201 class 1A whisker test, HM3 suffix meets JESD 201 class 2 whisker test

PRIMARY CHARACTERISTICS	
$I_{F(AV)}$	1.0 A
V_{RRM}	100 V, 200 V, 400 V, 600 V
I_R	5 μ A
V_F at $I_F = 1.0$ A	0.86 V
T_J max.	175 °C
Package	DO-220AA (SMP)
Diode variations	Single die

TYPICAL APPLICATIONS

General purpose, polarity protection, and rail-to-rail protection in both consumer and automotive applications.

MAXIMUM RATINGS ($T_A = 25$ °C unless otherwise noted)						
PARAMETER	SYMBOL	SE10PB	SE10PD	SE10PG	SE10PJ	UNIT
Device marking code		10B	10D	10G	10J	
Max. repetitive peak reverse voltage	V_{RRM}	100	200	400	600	V
Average forward current	$I_{F(AV)}$	1.0				A
Peak forward surge current 10 ms single half sine-wave superimposed on rated load	I_{FSM}	25				A
Operating junction and storage temperature range	T_J, T_{STG}	-55 to +175				°C

ELECTRICAL CHARACTERISTICS ($T_A = 25$ °C unless otherwise noted)					
PARAMETER	TEST CONDITIONS	SYMBOL	TYP.	MAX.	UNIT
Max. instantaneous forward voltage	$I_F = 1.0$ A	V_F (1)	$T_A = 25$ °C	0.960	1.05
			$T_A = 125$ °C	0.860	0.95
Max. reverse current	Rated V_R	I_R (2)	$T_A = 25$ °C	-	5.0
			$T_A = 125$ °C	4.8	50
Max. reverse recovery time	$I_F = 0.5$ A, $I_R = 1.0$ A, $I_{rr} = 0.25$ A	t_{rr}	780	-	ns
Typical junction capacitance	4.0 V, 1 MHz	C_J	7.0	-	pF

Notes

 (1) Pulse test: 300 μ s pulse width, 1 % duty cycle

 (2) Pulse test: Pulse width \leq 40 ms



THERMAL CHARACTERISTICS (T _A = 25 °C unless otherwise noted)						
PARAMETER	SYMBOL	SE10PB	SE10PD	SE10PG	SE10PJ	UNIT
Typical thermal resistance	R _{θJA} ⁽¹⁾	105				°C/W
	R _{θJL} ⁽¹⁾	25				
	R _{θJC} ⁽¹⁾	30				

Note

⁽¹⁾ Thermal resistance from junction to ambient and junction to lead mounted on PCB with 5.0 mm x 5.0 mm copper pad areas. R_{θJL} is measured at the terminal of cathode band. R_{θJC} is measured at the top center of the body.

IMMUNITY TO ELECTRICAL STATIC DISCHARGE TO THE FOLLOWING STANDARDS (T _A = 25 °C unless otherwise noted)					
STANDARD	TEST TYPE	TEST CONDITIONS	SYMBOL	CLASS	VALUE
AEC-Q101-001	Human body model (contact mode)	C = 100 pF, R = 1.5 kΩ	V _C	H3B	> 8 kV
AEC-Q101-002	Machine model (contact mode)	C = 200 pF, R = 0 Ω		M4	> 400 V
JESD22-A114	Human body model (contact mode)	C = 100 pF, R = 1.5 kΩ		3B	> 8 kV
JESD22-A115	Machine model (contact mode)	C = 200 pF, R = 0 Ω		C	> 400 V
IEC 61000-4-2 ⁽²⁾	Human body model (contact mode)	C = 150 pF, R = 330 Ω		4	> 8 kV
	Human body model (air-discharge mode) ⁽¹⁾	C = 150 pF, R = 330 Ω		4	> 15 kV

Notes

- ⁽¹⁾ Immunity to IEC 61000-4-2 air discharge mode has a typical performance > 30 kV
- ⁽²⁾ System ESD standard

ORDERING INFORMATION (Example)				
PREFERRED P/N	UNIT WEIGHT (g)	PREFERRED PACKAGE CODE	BASE QUANTITY	DELIVERY MODE
SE10PJ-M3/84A	0.024	84A	3000	7" diameter plastic tape and reel
SE10PJ-M3/85A	0.024	85A	10 000	13" diameter plastic tape and reel
SE10PJHM3/84A ⁽¹⁾	0.024	84A	3000	7" diameter plastic tape and reel
SE10PJHM3/85A ⁽¹⁾	0.024	85A	10 000	13" diameter plastic tape and reel

Note

- ⁽¹⁾ Automotive grade

RATINGS AND CHARACTERISTICS CURVES (T_A = 25 °C unless otherwise noted)

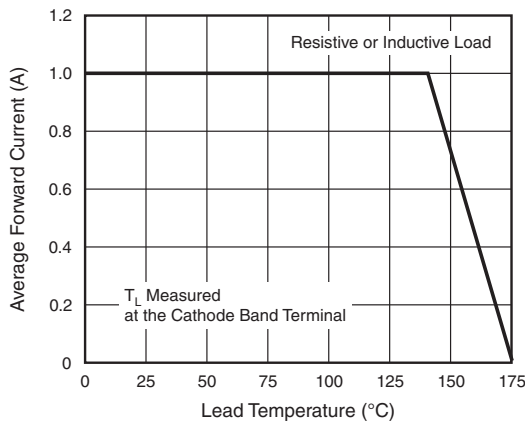

Fig. 1 - Max. Forward Current Derating Curve

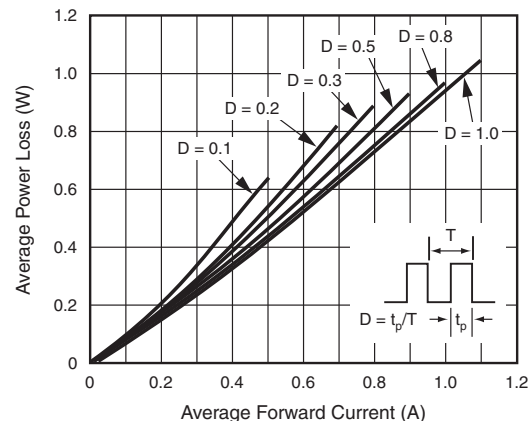

Fig. 2 - Forward Power Loss Characteristics

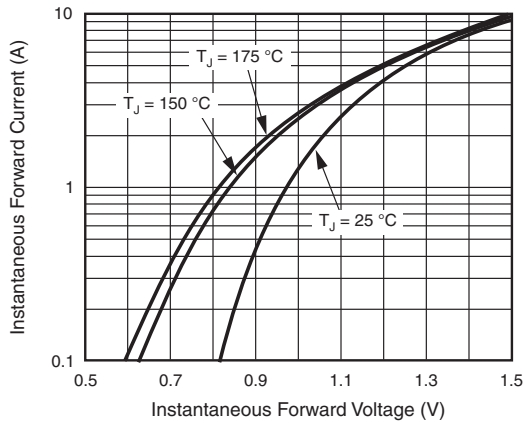

Fig. 3 - Forward Power Loss Characteristics

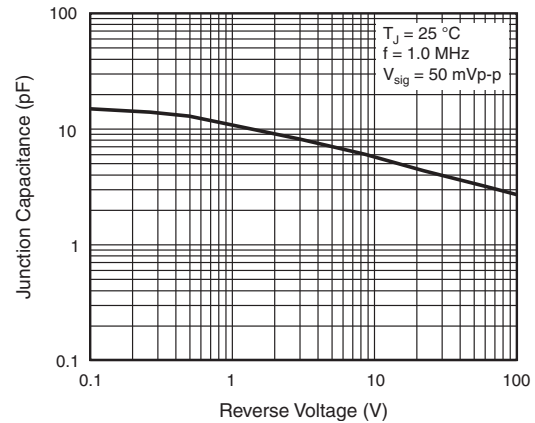

Fig. 5 - Typical Instantaneous Forward Characteristics

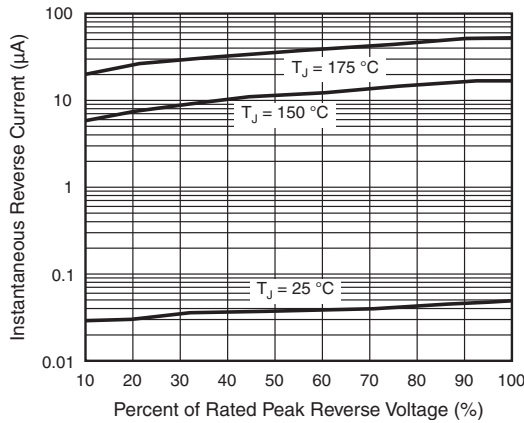
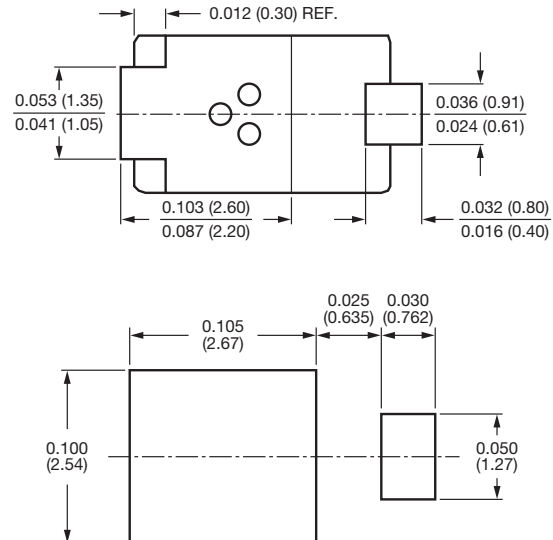
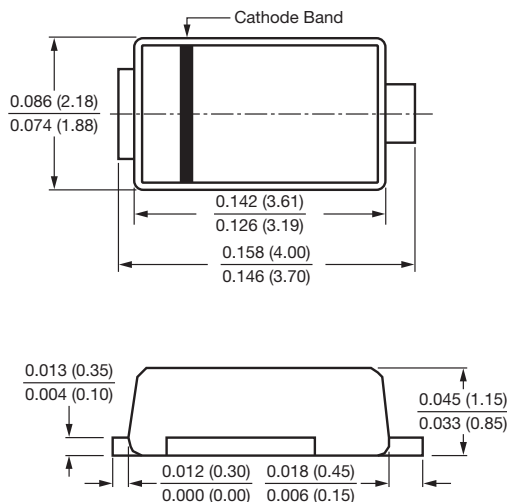

Fig. 4 - Typical Instantaneous Forward Characteristics

PACKAGE OUTLINE DIMENSIONS in inches (millimeters)

DO-220AA (SMP)





Disclaimer

ALL PRODUCT, PRODUCT SPECIFICATIONS AND DATA ARE SUBJECT TO CHANGE WITHOUT NOTICE TO IMPROVE RELIABILITY, FUNCTION OR DESIGN OR OTHERWISE.

Vishay Intertechnology, Inc., its affiliates, agents, and employees, and all persons acting on its or their behalf (collectively, "Vishay"), disclaim any and all liability for any errors, inaccuracies or incompleteness contained in any datasheet or in any other disclosure relating to any product.

Vishay makes no warranty, representation or guarantee regarding the suitability of the products for any particular purpose or the continuing production of any product. To the maximum extent permitted by applicable law, Vishay disclaims (i) any and all liability arising out of the application or use of any product, (ii) any and all liability, including without limitation special, consequential or incidental damages, and (iii) any and all implied warranties, including warranties of fitness for particular purpose, non-infringement and merchantability.

Statements regarding the suitability of products for certain types of applications are based on Vishay's knowledge of typical requirements that are often placed on Vishay products in generic applications. Such statements are not binding statements about the suitability of products for a particular application. It is the customer's responsibility to validate that a particular product with the properties described in the product specification is suitable for use in a particular application. Parameters provided in datasheets and / or specifications may vary in different applications and performance may vary over time. All operating parameters, including typical parameters, must be validated for each customer application by the customer's technical experts. Product specifications do not expand or otherwise modify Vishay's terms and conditions of purchase, including but not limited to the warranty expressed therein.

Except as expressly indicated in writing, Vishay products are not designed for use in medical, life-saving, or life-sustaining applications or for any other application in which the failure of the Vishay product could result in personal injury or death. Customers using or selling Vishay products not expressly indicated for use in such applications do so at their own risk. Please contact authorized Vishay personnel to obtain written terms and conditions regarding products designed for such applications.

No license, express or implied, by estoppel or otherwise, to any intellectual property rights is granted by this document or by any conduct of Vishay. Product names and markings noted herein may be trademarks of their respective owners.